

USER'S MANUAL

RCO-1000-ASL Fanless Mini Computer



Table of Contents

Prefaces	04
Revision	04
Disclaimer	04
Copyright Notice	04
Trademarks Acknowledgment	04
Environmental Protection Announcement	04
Safety Precautions	05
Technical Support and Assistance	06
Conventions Used in this Manual	06
Package Contents	07
Ordering Information	07
Optional Accessory	08
Chapter 1 Product Introductions	09
1.1 Overview	10
Key Feature	10
1.2 Hardware Specification	11
1.3 System I/O	14
1.4 Mechanical Dimension	22
Chapter 2 Mechanical Specifications	25
2.1 Switch and connector Locations	26
2.1.1 Top View	26
2.1.2 Bottom View	27
2.2 Connector / Switch Definition	28
2.3 I/O Interface Descriptions	29
Chapter 3 System Setup	45
3.1 Set torque force to 3.5 kgf-cm to execute all the screwing and unscrewing	46
3.2 Removing chassis bottom cover	46
3.3 Removing HDD bracket	47
3.4 Removing chassis top cover	49
3.5 Installing SODIMM	50
3.6 Installing Wi-Fi Module and Antenna	52
3.7 Installing Communication Module and Antenna	55
3.8 Installing SIM card	58
3.9 Installing Wall Mount	59
3.10 Installing VESA mount kit	60
3.11 Installing side mount kit	62
3.12 Installing DIN Rail Holder	63
Chapter 4 BIOS Setup	64
4.1 BIOS Introduction	65
4.2 Main Setup	66
4.3 Advanced Setup	67
4.3.1 CPU Configuration	68

4.3.2 PCH-FW Configuration	70
4.3.3 Trusted Computing	71
4.3.4 ACPI Settings	72
4.3.5 Super IO Configuration	73
4.3.6 Hardware Monitor	80
4.3.7 Power IGN Mode	82
4.3.8 S5 RTC Wake Settings	83
4.3.9 Serial Port Console Redirection	84
4.3.10 USB Configuration	85
4.3.11 Network Stack Configuration	86
4.3.12 NVMeConfiguration	87
4.4 Chipset	88
4.4.1 System Agent (SA) Configuration	89
4.4.2 PCH-IO Configuration	92
4.5 Security	97
4.6 Boot	100
4.7 Save & Exit	101
Appendix WDT & GPIO	102
WDT Sample Code	103
GPIO Sample Code	104

Prefaces

Revision

Revision	Description	Date
1.0	Manual Released	2026/3/3

Disclaimer

All specifications and information in this User's Manual are believed to be accurate and up to date. Premio Inc. does not guarantee that the contents herein are complete, true, accurate or non-misleading. The information in this document is subject to change without notice and does not represent a commitment on the part of Premio Inc.

Premio Inc. disclaims all warranties, express or implied, including, without limitation, those of merchantability, fitness for a particular purpose with respect to contents of this User's Manual. Users must take full responsibility for the application of the product.

Copyright Notice

All rights reserved. No part of this manual may be reproduced or transmitted in any form or by any means, electronic or mechanical, including photocopying, recording, or information storage and retrieval systems, without the prior written permission of Premio Inc. Copyright © Premio Inc.

Trademarks Acknowledgment

Intel®, Celeron® and Pentium® are trademarks of Intel Corporation.

Windows® is registered trademark of Microsoft Corporation.

AMI is trademark of American Megatrend Inc.

IBM, XT, AT, PS/2 and Personal System/2 are trademarks of International Business Machines Corporation

All other products and trademarks mentioned in this manual are trademarks of their respective owners.

Environmental Protection Announcement

Do not dispose this electronic device into the trash while discarding. Please recycle to minimize pollution and ensure environment protection.

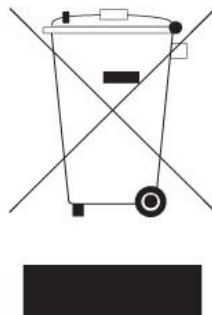

Safety Precautions

Before installing and using the equipment, please read the following precautions:

- Put this equipment on a reliable surface during installation. Dropping it or letting it fall could cause damage.
- The power outlet shall be installed near the equipment and shall be easily accessible.
- Turn off the system power and disconnect the power cord from its source before making any installation. Be sure both the system and the external devices are turned OFF. Sudden surge of power could ruin sensitive components. Make sure the equipment is properly grounded.
- When the power is connected, never open the equipment. The equipment should be opened only by qualified service personnel.
- Make sure the voltage of the power source is correct before connecting the equipment to the power outlet.
- Disconnect this equipment from the power before cleaning. Use a damp cloth. Do not use liquid or spray detergents for cleaning.
- Avoid the dusty, humidity and temperature extremes.
- Do not place heavy objects on the equipment.
- If the equipment is not used for long time, disconnect it from the power to avoid being damaged by transient over-voltage.
- The storage temperature shall be above -30°C and below 85°C .
- The computer is provided with a battery-powered real-time clock circuit. There is a danger of explosion if incorrectly replaced. Replace only with the same or equivalent type recommended by the manufacturer.
- If one of the following situation arises, get the equipment checked by service personnel:
 - The power cord or plug is damaged.
 - Liquid has penetrated into the equipment.
 - The equipment has been exposed to moisture.
 - The equipment does not work well or it cannot work according the user's manual.
 - The equipment has been dropped and damaged.
 - The equipment has obvious signs of breakage.

Technical Support and Assistance

1. Visit the Premio Inc website at www.premioinc.com where you can find the latest information about the product.
2. Contact your distributor, our technical support team or sales representative for technical support if you need additional assistance. Please have following information ready before you call:
 - Model name and serial number
 - Description of your peripheral attachments
 - Description of your software (operating system, version, application software, etc.)
 - A complete description of the problem
 - The exact wording of any error messages

Conventions Used in this Manual

**WARNING**

This indication alerts operators to an operation that, if not strictly observed, may result in severe injury.

**CAUTION**

This indication alerts operators to an operation that, if not strictly observed, may result in safety hazards to personnel or damage to equipment.

**NOTE**

This indication provides additional information to complete a task easily.

Package Contents

Before installation, please ensure all the items listed in the following table are included in the package.

Item	Description	Q'ty
1	RCO-1000-ASL Series	1
2	Wall Mount Kit	1
3	Accessory Kit	1

Ordering Information

Model No.	Product Description
RCO-1000-ASL-x7433RE-10	Fanless Mini PC with Intel® Atom® x7433RE Processor, 1x EDGEBoost IO
RCO-1000-ASL-x7835RE-10	Fanless Mini PC with Intel® Atom® x7835RE Processor, 1x EDGEBoost IO
RCO-1000-ASL-x7433RE-20	Fanless Mini PC with Intel® Atom® x7433RE Processor, 2x EDGEBoost IO
RCO-1000-ASL-x7835RE-20	Fanless Mini PC with Intel® Atom® x7835RE Processor, 2x EDGEBoost IO
RCO-1000-ASL-x7433RE-20-OOB	Fanless Mini PC with Intel® Atom® x7433RE Processor, 1x RJ45 OOB, 2x EDGEBoost IO
RCO-1000-ASL-x7835RE-20-OOB	Fanless Mini PC with Intel® Atom® x7835RE Processor, 1x RJ45 OOB, 2x EDGEBoost IO
RCO-1000-ASL-x7433RE-30	Fanless Mini PC with Intel® Atom® x7433RE Processor, 3x EDGEBoost IO
RCO-1000-ASL-x7835RE-30	Fanless Mini PC with Intel® Atom® x7835RE Processor, 3x EDGEBoost IO

Optional Accessories

Model No.	Product Description
1-TPCD00002	Power Cord, European Type, 180cm
1-TPCD00001	Power Cord, 3-pin UK Type, 180cm
1-TPCD00005	Power Cord, 3-pin US Type, 180cm
3-RC1AS0401S10	RCO-1000-ASL-10 Series : Side Mount Kit
3-SIDE-0003	RCO-1000-ASL-20 Series : Side Mount Kit
3-SIDE-0004	RCO-1000-ASL-30 Series : Side Mount Kit
3-VESA-0003	RCO-1000 Series VESA Mount Kit
3-RC1AS1101S10	RCO-1000-ASL-10 Series Din Rail-2 Mounting Kit
3-DINR-0004	RCO-1000-ASL-20/RCO-1000-ASL-30 : DIN-Rail Mount Kit
3-RC1200IGKIT	MOD, PWR IGNITION, KIT, 1000-ASL
3-RC12002SKIT	MOD, EBIO, 2XCOM, 3, 4, 1000-ASL
3-RC12002S1IT	MOD, EBIO, 2XCOM, 5, 6, 1000-ASL
3-RC12004UKIT	MOD, EBIO, 4XUSB2.0, 1000-ASL
3-RC1200DDKIT	MOD, EBIO, DP, DIO, 4IN, 4OUT, 1000-ASL
3-RC1200HOKIT	MOD, EBIO, HDMI, DIO, 4IN, 4OUT, 1000-ASL

Chapter 1

Product Introductions

1.1 Overview

The RCO-1000-ASL Series is an ultra-compact rugged computer built to scale with evolving edge applications, featuring a modular architecture for I/O expansion and seamless industrial integration.

Key Features

- Intel® Atom® x7433RE/x7835RE Processors
- Wide Operating Temperature (-40°C to 70°C)
- MIL-STD-810H Compliant (5G Shock & 5Grms Vibration)
- 5G and Wi-Fi Support
- Out-of-Band Management
- Power Ignition Management
- Built-in CAN Bus
- UL Listed

Model No.	Rear Panel	Front Panel
RCO-1000-ASL-10 1x EDGEBoost IO		
RCO-1000-ASL-20 2x EDGEBoost IO		
RCO-1000-ASL-20-OOB 2x EDGEBoost IO 1x RJ45 OOB		
RCO-1000-ASL-30 3x EDGEBoost IO		

1.2 Hardware Specification

System

Processor

- Intel Atom® x7433RE Processor 6M Cache, up to 3.4 GHz 8 core 9W (Default)
- Intel Atom® x7835RE Processor 6M Cache, up to 3.60 GHz 8 core 12W

System Chipset

SoC integrated

LAN Chipset

- 2.5 GbE1: Intel I226 (Support Wake-on-LAN and PXE)
- 2.5 GbE2: Intel I226 (Support Wake-on-LAN and PXE)

Audio Codec

Realtek ALC888C

System Memory

1x 262-Pin DDR5 4800/5600 MT/s SO-DIMM. Max. up to 32GB Non-ECC

Graphics

Intel® UHD Graphics

BIOS

AMI 256Mbit SPI BIOS

Watchdog

Software Programmable Supports 1~255 sec. System Reset

TPM

TPM 2.0

Display

Display Port

1x DisplayPort (4096 x 2304@60Hz)

HDMI

1x HDMI 1.4b (Resolution up to 3840x2160 @ 30 Hz)

Multiple Display

Dual Display

Storage

SSD/HDD

1x Internal 2.5" SATA HDD Bay (support H=9.5 mm)

SIM Socket

2x External SIM socket

M.2

1x M.2 B key-1 SATA/PCIE/USB 3.0 (2242/3042/3052) for Storage

Expansion

M.2

1x M.2 E key Type: 2230 (Support PCIe x1 + USB 2.0 signal for WiFi and Bluetooth)

Expansion Modules

Optional:

- 2-port COM module with Super I/O Chipset
- 4-Port USB module with USB hub
- 1-Port DP 1.4 and DIO (4 in / 4 out, Isolated)
- 1-Port HDMI 2.0 and DIO (4 in / 4 out, Isolated)

RCO-1000-ASL-20-OOB only

- 1-Port OOB and 2-port COM (RS232/422/485)

I/O

COM	2x RS-232/422/485		
USB	3x USB 3.2 Gen 2 (10 Gbps) 1x USB 2.0		
LAN	2x RJ45 (2.5 GbE)		
OOB	<ul style="list-style-type: none"> RCO-1000-ASL-20-OOB only 1x RJ45 (OOB Management Module, Optional)		
Audio	1x Mic-in, 1x Line-out		
CAN	2x CAN 2.0 A/B 2-pin Internal header		
EDGEBoost I/O Bracket	RCO-1000-ASL-10	RCO-1000-ASL-20	RCO-1000-ASL-30
	1x EDGEBoost I/O Bracket (By mini PCIe interface, Proprietary Module)	3x EDGEBoost I/O Bracket (By mini PCIe interface, Proprietary Module)	5x EDGEBoost I/O Bracket (By mini PCIe interface, Proprietary Module)
Others	6x WiFi Antenna Holes 1x Power Switch, 1x AT/ATX Switch, 1x Remote Power On/Off 1x Internal CMOS Battery Cable 1x 4-PIN FAN Connector 1x Ground Screw 1x HDD LED, 1x Reset		

Operating System

Windows	Windows 10/11
Linux	Linux Ubuntu 22.04

Power

Power Mode	AT, ATX
Power Ignition Sensing	Adjustable power ignition management can be achieved through BIOS and optional daughter board.
Power Supply Voltage	9~36VDC
Power Connector	3-pin Terminal Block
Power Adapter	Optional AC/DC 12V/5A, 60W
Power Protection	OVP (Over Voltage Protection) OCP (Over Current Protection) Reverse Protection

Environment

Operating Temp.	-40°C to 70°C
Storage Temp.	-40°C to 85°C
Relative Humidity	10% to 95% (non-condensing)
Vibration	With SSD: 5 Grms, 5 - 500 Hz, 0.5 hr/axis With HDD: 1 Grms, 5 - 500 Hz, 0.5 hr/axis
Shock	With SSD: 50G, half sine, 11ms
Certification	UL, CE, FCC Class A

Physical

Construction	Extruded Aluminum with Heavy Duty Metal		
Dimensions (W x H x D)	RCO-1000-ASL-10	RCO-1000-ASL-20	RCO-1000-ASL-30
	150 (W) x 105 (D) x 49 (H) mm	150 (W) x 105 (D) x 65 (H) mm	150 (W) x 105 (D) x 83 (H) mm
Weights	0.9 kg	1 kg	1.2 kg
Mounting Options	Wall Mounting SIDE / VESA / DIN-Rail Mounting (Optional)		

1.3 System I/O

1.3.1 RCO-1000-ASL-10

Front Panel

- **ATX power on/off switch**
Press to power-on or power-off the system
- **AT/ATX mode select switch**
Used to select AT or ATX power mode
- **HDD LED**
Indicates the status of the hard drive
- **USB 3.2 Gen 2**
Used to connect USB 3.2 device
- **USB 2.0 port**
Used to connect USB 2.0 device
- **SIM card**
Used to insert a SIM card
- **LAN port**
Used to connect the system to a local area network
- **Line-out**
Used to connect a speaker
- **Mic-in**
Used to connect a microphone
- **Remote power on/off**
Used to plug a power on/off with terminal block
- **Reset Hole**
Used to reset the system
- **Antenna hole**
Used to connect an antenna for optional Mini-PCIe WiFi module

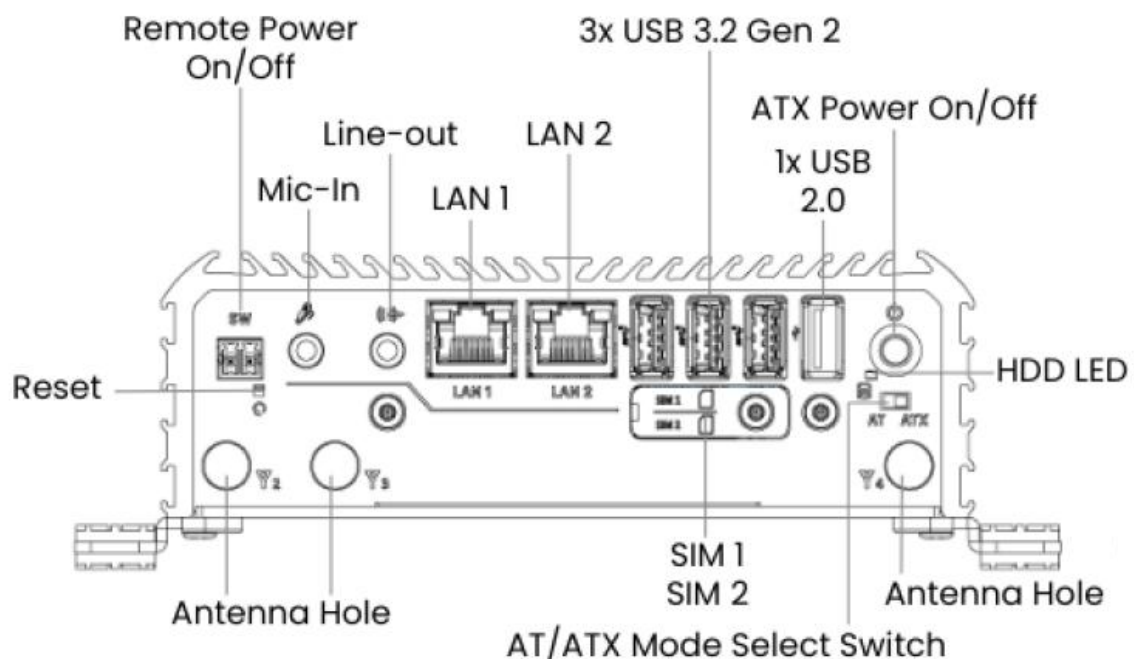

Rear Panel

- DC IN**
 Used to plug a DC power input with terminal block
- DisplayPort**
 Used to connect a DisplayPort monitor
- COM port**
 COM1 ~ COM2 support RS232/422/485 serial device
- HDMI port**
 Used to connect a HDMI monitor or connect optional split cable for dual display mode
- Antenna hole**
 Used to connect an antenna for optional Mini-PCIe WiFi module
- EDGEBoost I/O bracket**
 Used to customized I/O output

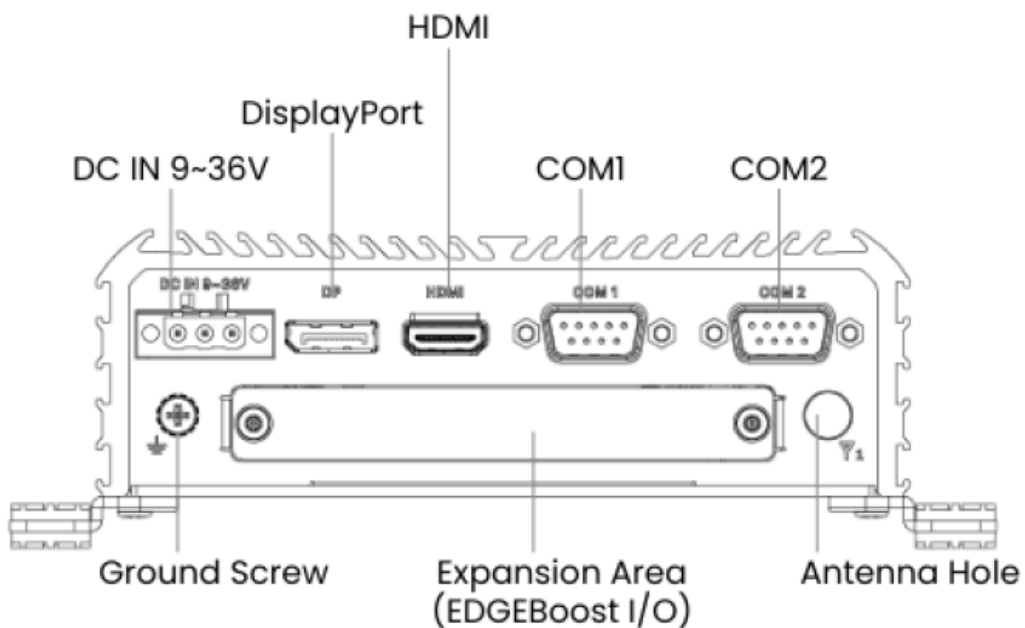

Available EDGEBoost I/O for Rear Panel

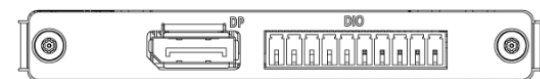

1x DP Port and 1x DIO (4 in / 4 out, Isolated)

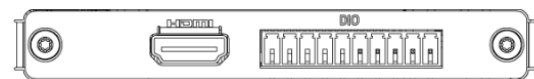

1x HDMI Port and 1x DIO (4 in / 4 out, Isolated)

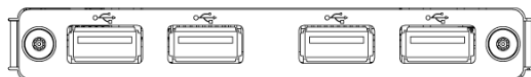

4x USB Ports



2x COM Ports

1.3.2 RCO-1000-ASL-20

Front Panel

- **ATX power on/off switch**
Press to power-on or power-off the system
- **AT/ATX mode select switch**
Used to select AT or ATX power mode
- **HDD LED**
Indicates the status of the hard drive
- **USB 3.2 Gen 2**
Used to connect USB 3.2 device
- **USB 2.0 port**
Used to connect USB 2.0 device
- **SIM card**
Used to insert a SIM card
- **LAN port**
Used to connect the system to a local area network
- **Line-out**
Used to connect a speaker
- **Mic-in**
Used to connect a microphone
- **Remote power on/off**
Used to plug a power on/off with terminal block
- **Reset Hole**
Used to reset the system
- **Antenna hole**
Used to connect an antenna for optional Mini-PCIe WiFi module

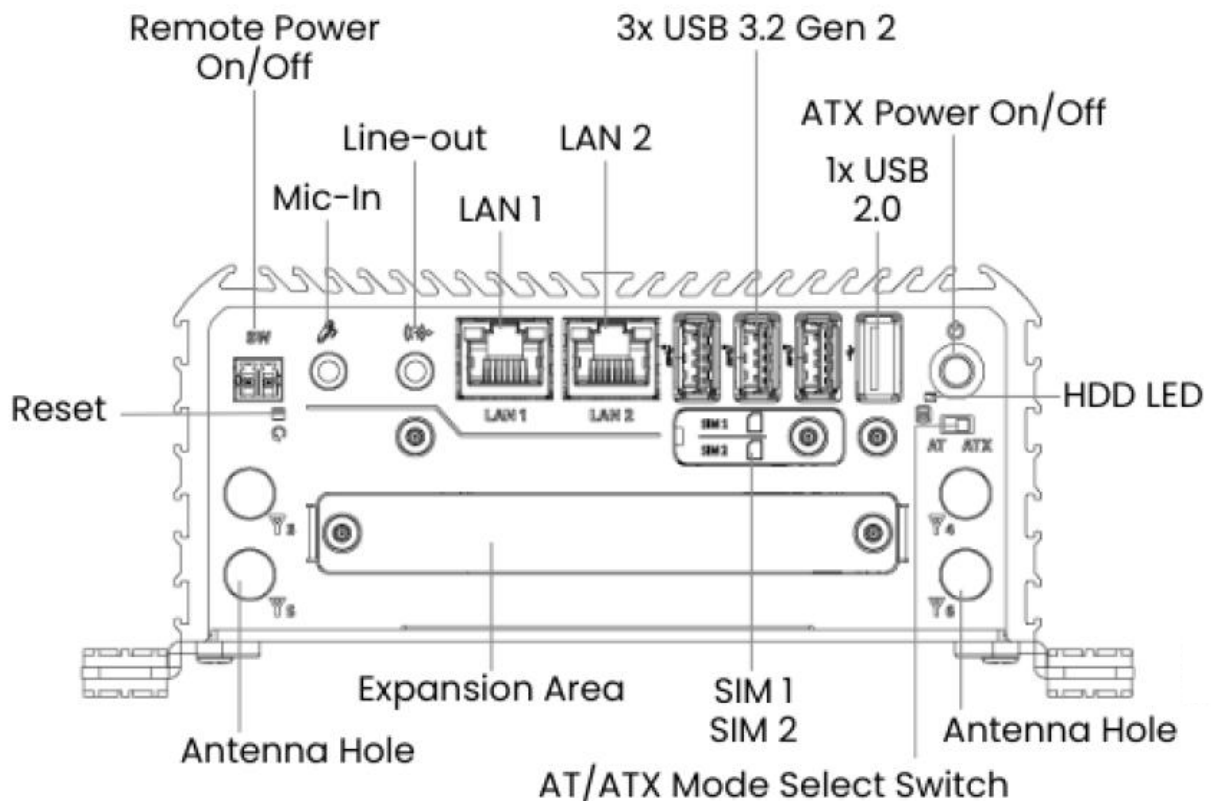

Rear Panel

- DC IN**
 Used to plug a DC power input with terminal block
- DisplayPort**
 Used to connect a DisplayPort monitor
- COM port**
 COM1 ~ COM2 support RS232/422/485 serial device
- HDMI port**
 Used to connect a HDMI monitor or connect optional split cable for dual display mode
- Antenna hole**
 Used to connect an antenna for optional Mini-PCIe WiFi module
- EDGEBoost I/O bracket**
 Used to customized I/O output

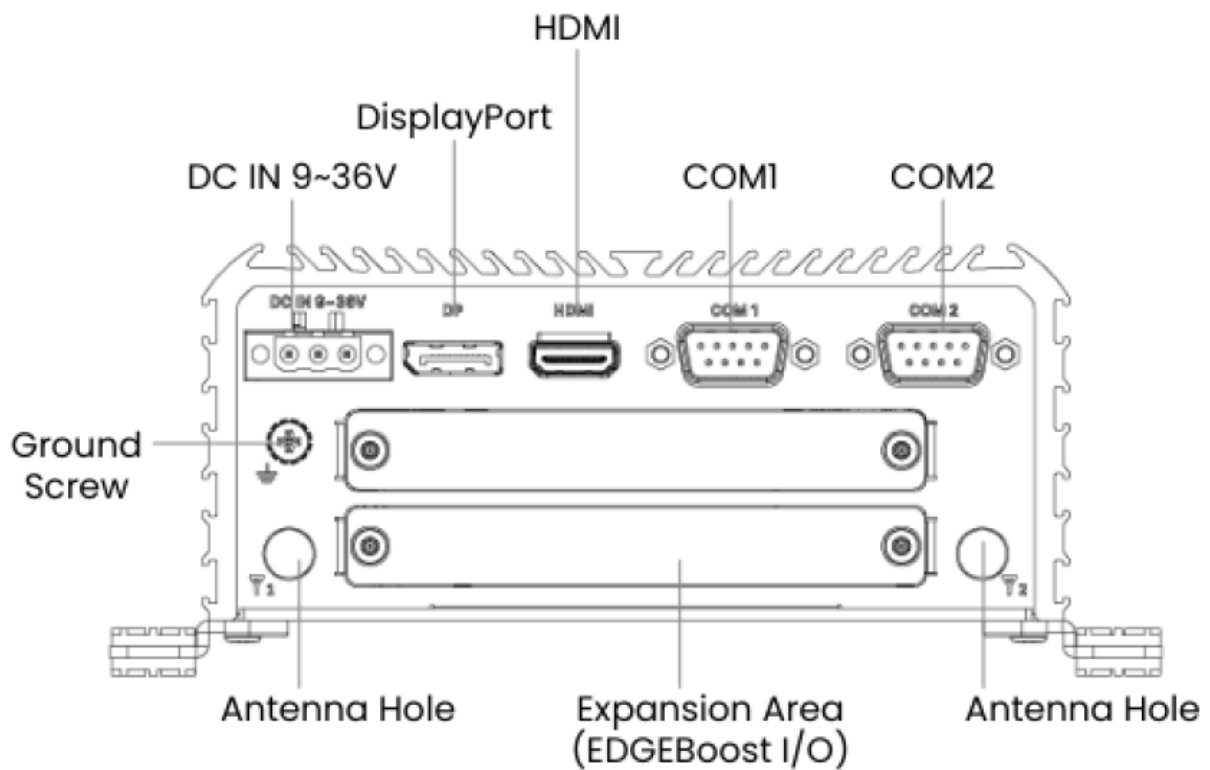

Available EDGEBoost I/O for Rear Panel

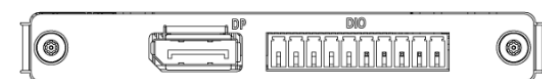

1x DP Port and 1x DIO (4 in / 4 out, Isolated)

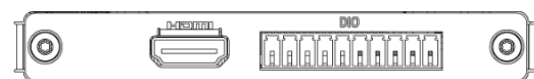

1x HDMI Port and 1x DIO (4 in / 4 out, Isolated)

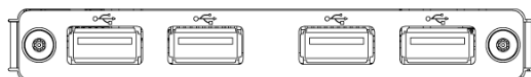

4x USB Ports



2x COM Ports

1.3.3 RCO-1000-ASL-20-OOB

Front Panel

- **ATX power on/off switch**
Press to power-on or power-off the system
- **AT/ATX mode select switch**
Used to select AT or ATX power mode
- **HDD LED**
Indicates the status of the hard drive
- **USB 3.2 Gen 2**
Used to connect USB 3.2 device
- **USB 2.0 port**
Used to connect USB 2.0 device
- **SIM card**
Used to insert a SIM card
- **OOB port**
The OOB can be connected through RJ45 port
- **LAN port**
Used to connect the system to a local area network
- **Line-out**
Used to connect a speaker
- **Mic-in**
Used to connect a microphone
- **Remote power on/off**
Used to plug a power on/off with terminal block
- **Reset Hole**
Used to reset the system
- **Antenna hole**
Used to connect an antenna for optional Mini-PCIe WiFi module

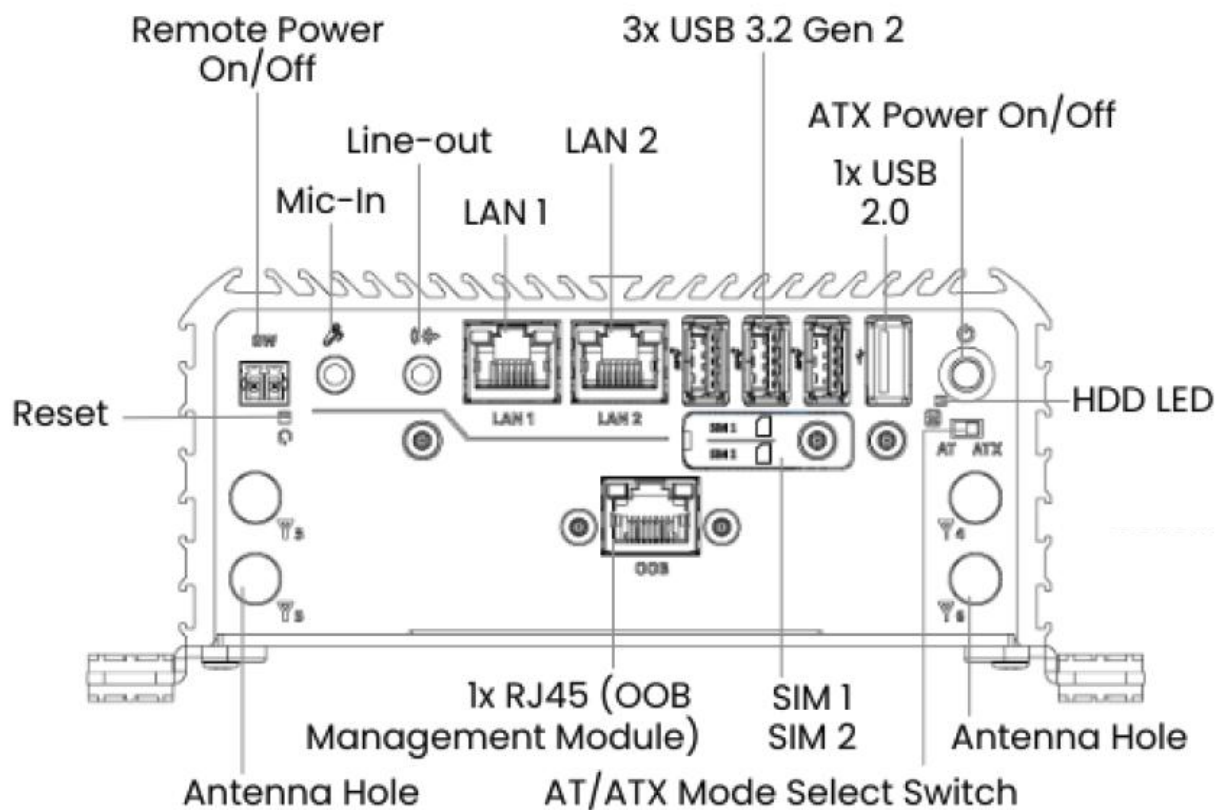

Rear Panel

- DC IN**
 Used to plug a DC power input with terminal block
- DisplayPort**
 Used to connect a DisplayPort monitor
- COM port**
 COM1 ~ COM4 support RS232/422/485 serial device
- HDMI port**
 Used to connect a HDMI monitor or connect optional split cable for dual display mode
- Antenna hole**
 Used to connect an antenna for optional Mini-PCIe WiFi module
- EDGEBoost I/O bracket**
 Used to customized I/O output

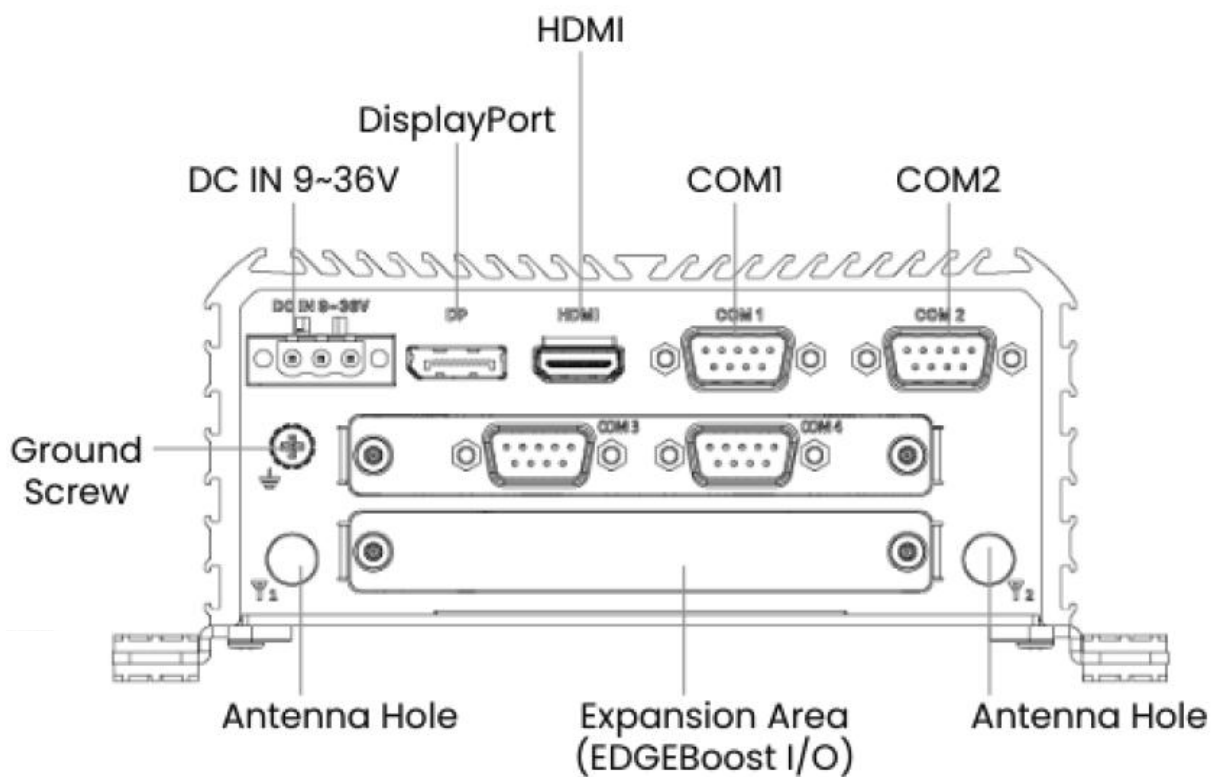

Available EDGEBoost I/O for Rear Panel

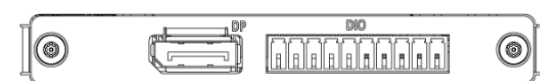

1x DP Port and 1x DIO (4 in / 4 out, Isolated)

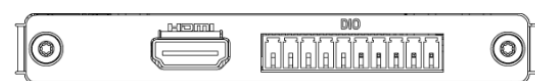

1x HDMI Port and 1x DIO (4 in / 4 out, Isolated)

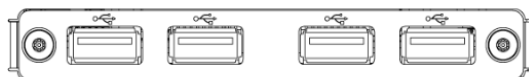

4x USB Ports



2x COM Ports

1.3.4 RCO-1000-ASL-30

Front Panel

- **ATX power on/off switch**
Press to power-on or power-off the system
- **AT/ATX mode select switch**
Used to select AT or ATX power mode
- **HDD LED**
Indicates the status of the hard drive
- **USB 3.2 Gen 2**
Used to connect USB 3.2 device
- **USB 2.0 port**
Used to connect USB 2.0 device
- **SIM card**
Used to insert a SIM card
- **LAN port**
Used to connect the system to a local area network
- **Line-out**
Used to connect a speaker
- **Mic-in**
Used to connect a microphone
- **Remote power on/off**
Used to plug a power on/off with terminal block
- **Reset Hole**
Used to reset the system
- **Antenna hole**
Used to connect an antenna for optional Mini-PCIe WiFi module

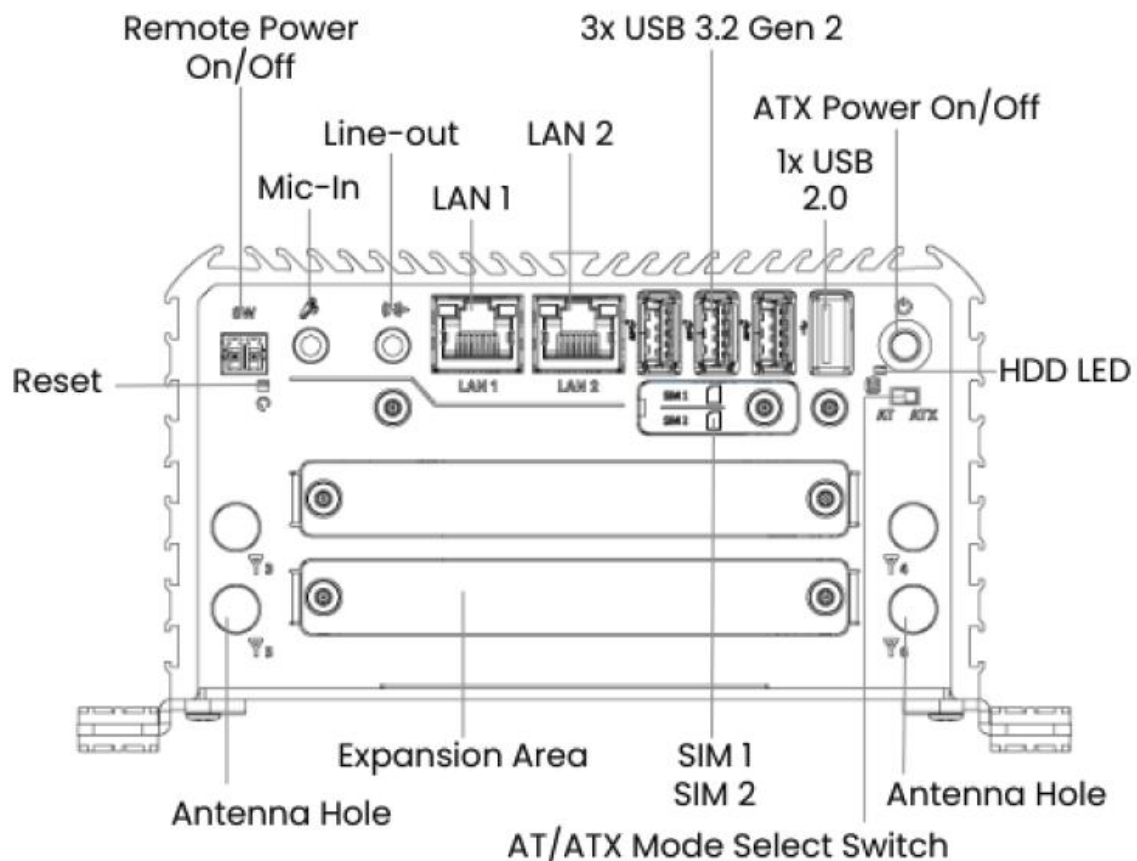

Rear Panel

- DC IN**
 Used to plug a DC power input with terminal block
- DisplayPort**
 Used to connect a DisplayPort monitor
- COM port**
 COM1 ~ COM2 support RS232/422/485 serial device
- HDMI port**
 Used to connect a HDMI monitor or connect optional split cable for dual display mode
- Antenna hole**
 Used to connect an antenna for optional Mini-PCIe WiFi module
- EDGEBoost I/O bracket**
 Used to customized I/O output

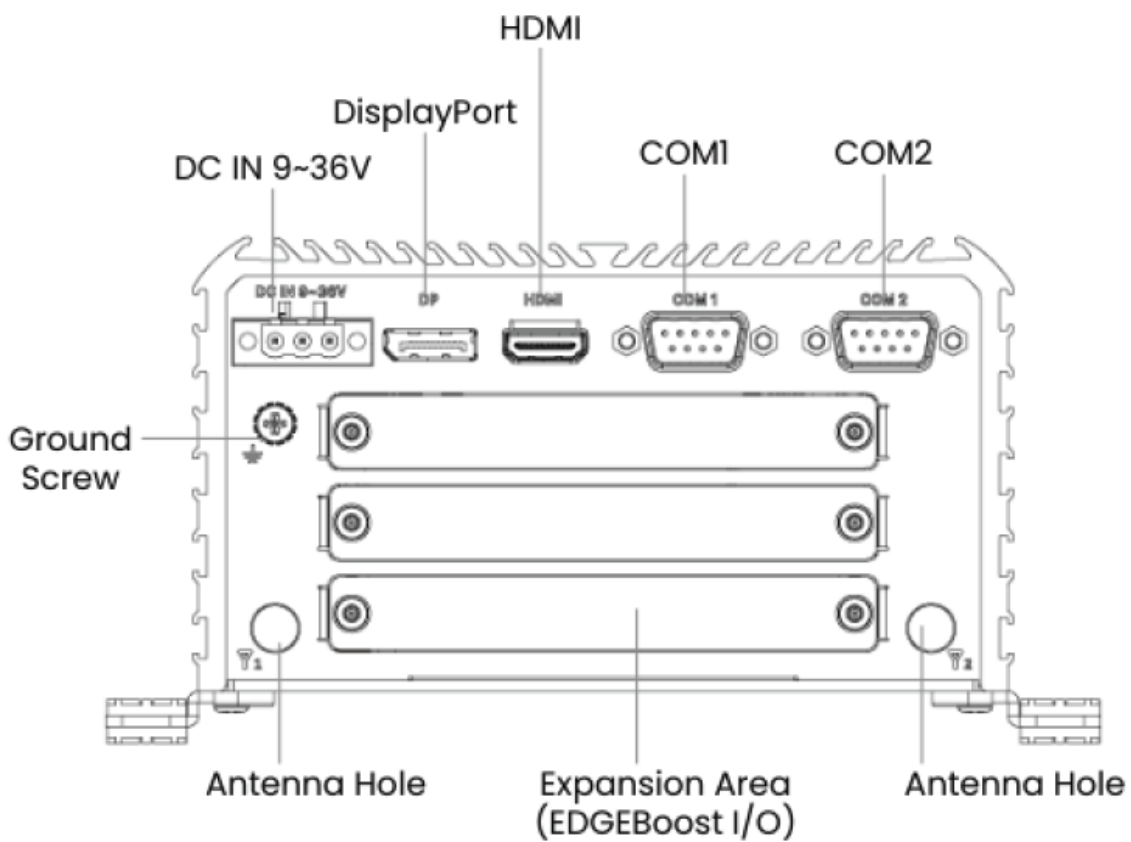

Available EDGEBoost I/O for Rear Panel



1x DP Port and 1x DIO (4 in / 4 out, Isolated)

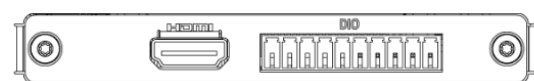

1x HDMI Port and 1x DIO (4 in / 4 out, Isolated)

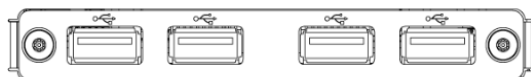

4x USB Ports



2x COM Ports

1.4.2 RCO-1000-ASL-20

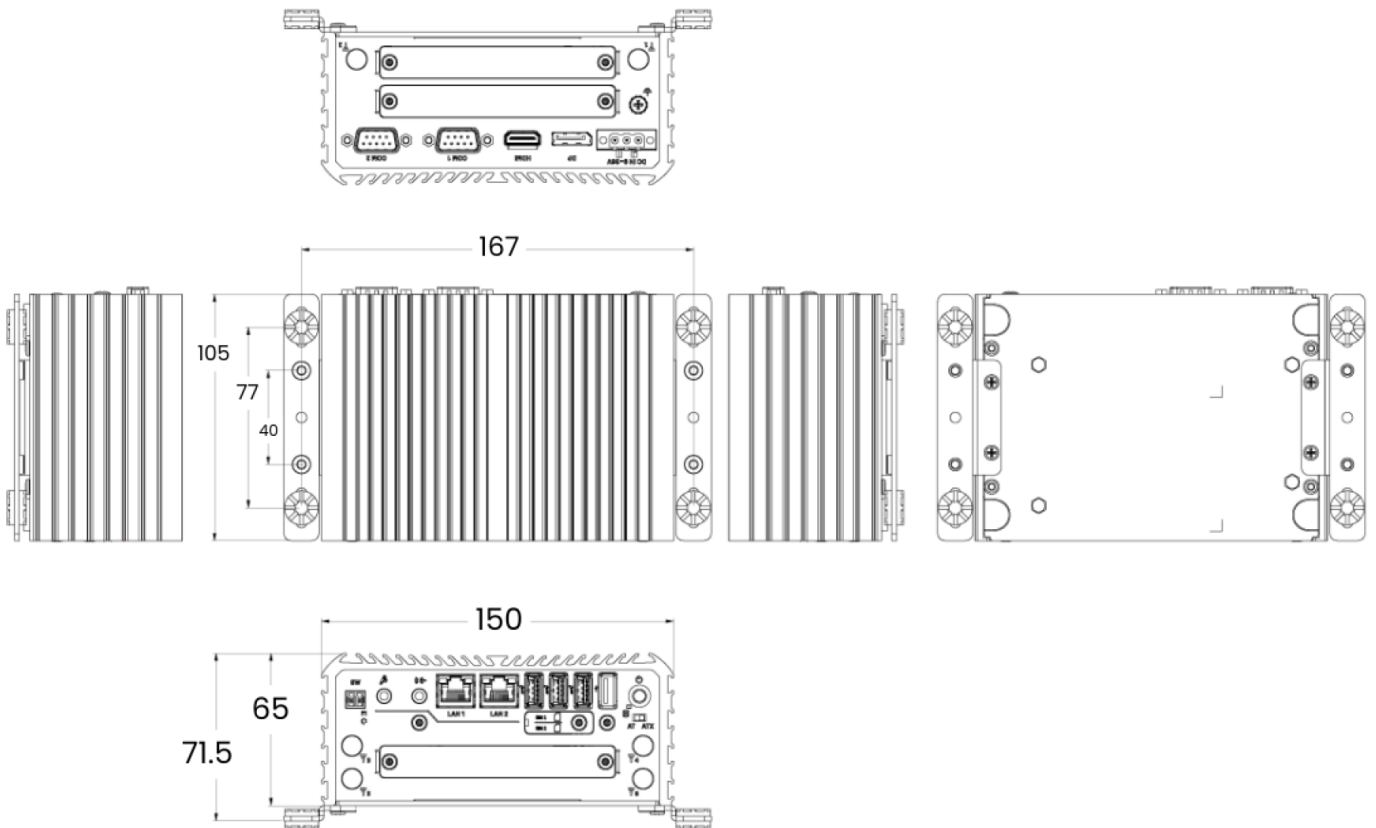

1.4.3 RCO-1000-ASL-20-OOB

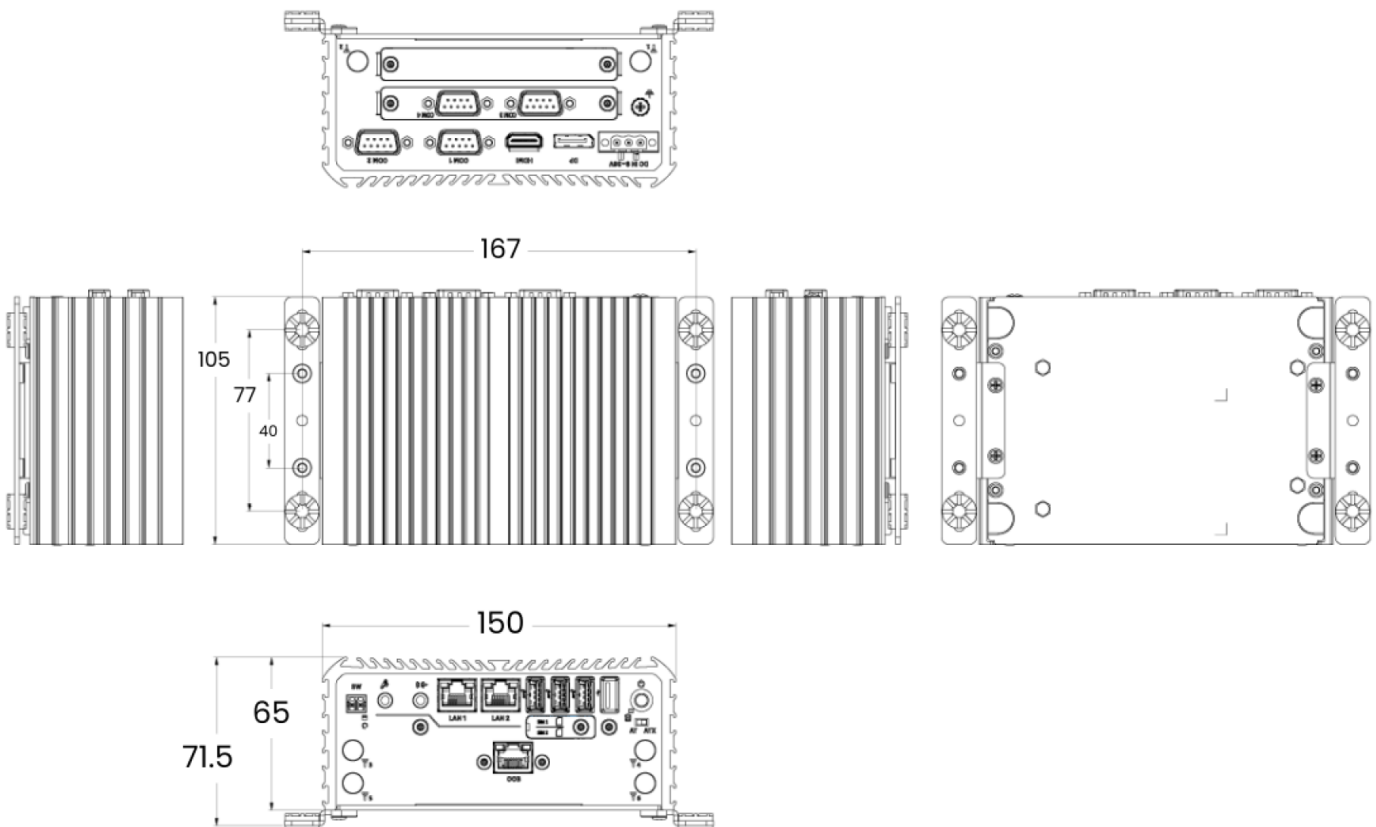

Chapter 2

Mechanical Specifications

2.1 Switch and Connector Locations

2.1.1 Top View

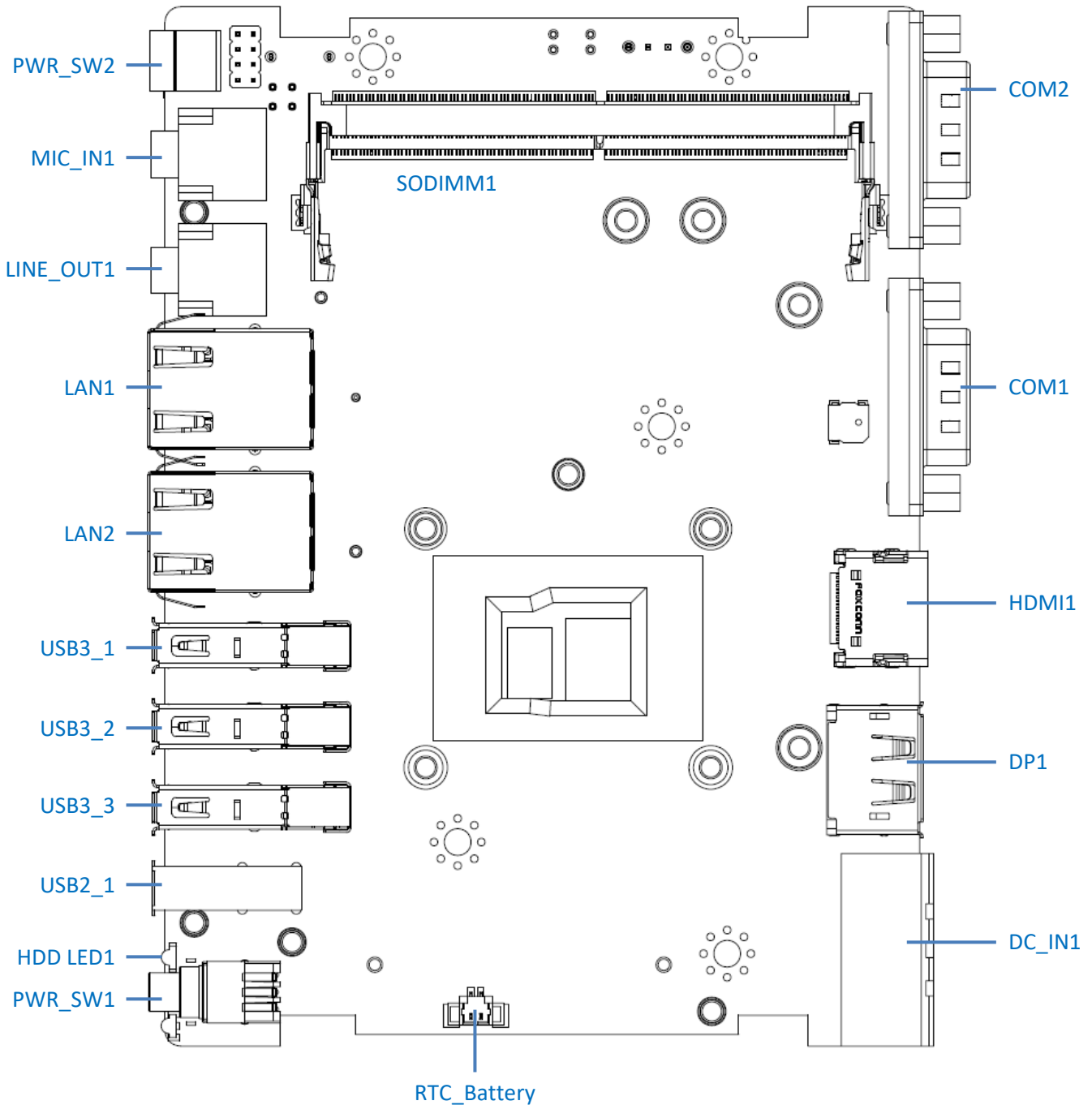

2.1.2 Bottom View

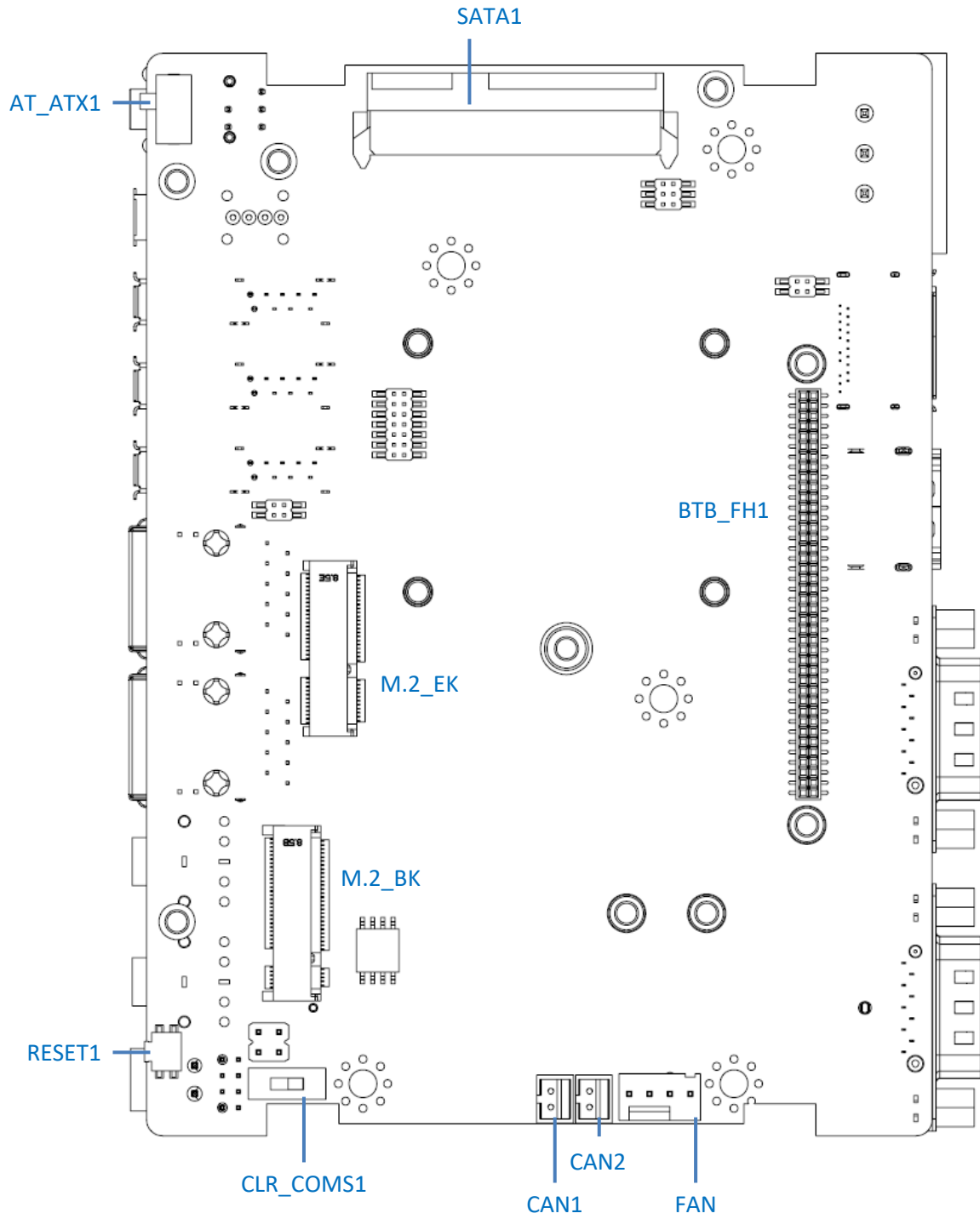

2.2 Connector / Switch Definition

Connector Location	Definition
DC_IN1	3-Pin DC +9~36V Power Input Connector
PWR_SW1	Power Switch (With LED Light)
PWR_SW2	Remote Power Switch
DP1	Display Port
HDMI1	High Display Multimedia Interface
COM1-2	RS232 / RS422 / RS485 Connector
USB2_1	USB2.0 Port
USB3_1 - 3	USB 3.2 Gen 2 Port
LAN1-2	2.5G bit/s LAN Port
MIC_IN1	Mic-in Jack
LINE_OUT1	LINE-OUT Jack
HDD_LED1	HDD Access LED Status
AT_ATX1	AT / ATX Power Mode Switch
SATA1	SATA with Power Connector
FAN	Smart FAN Connector
CAN1 - 2	CAN Bus Connector
M.2_KE1	M.2 E-Key Socket
M.2_BK1	M.2 B-Key Socket
RESET1	Reset Switch
CLR_COMS1	Clear COMS

2.3 I/O Interface Descriptions

2.3.1 DC Power Input Connector (+9~36V)

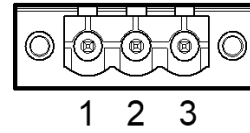
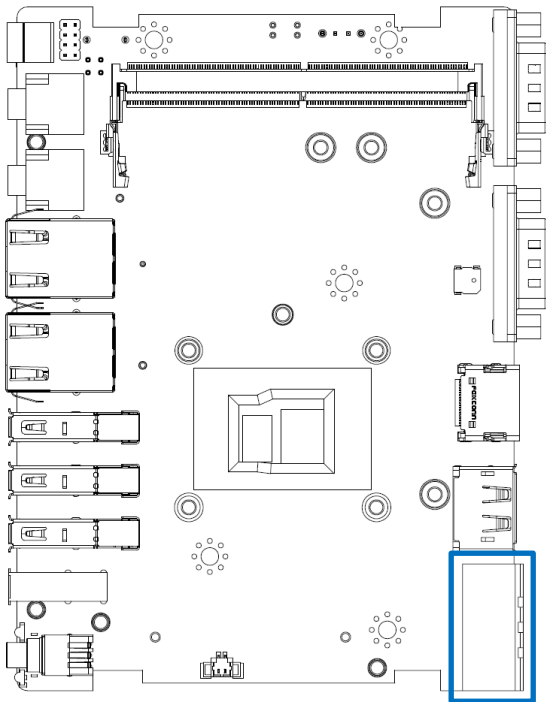

DC_IN1

Connector Type: Terminal Block
1X3 3-pin, 5.0mm pitch

Switch	Definition
1	9 ~ 36 VIN
2	Car Mode
3	GND

2.3.2 Power Botton (With LED Light)

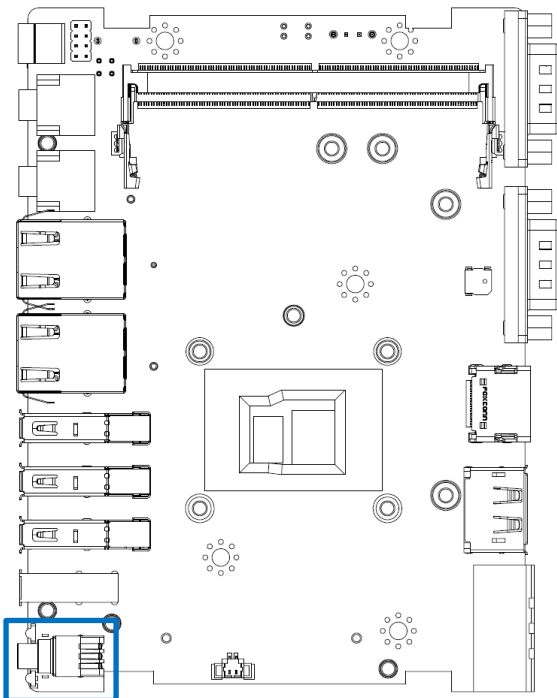

PWR_SW1

Pin	Definition	Pin	Definition
1	NC	4	GND
2	Power Button	5	+V3.3S
3	NC	6	GND

2.3.3 Remote Power Switch

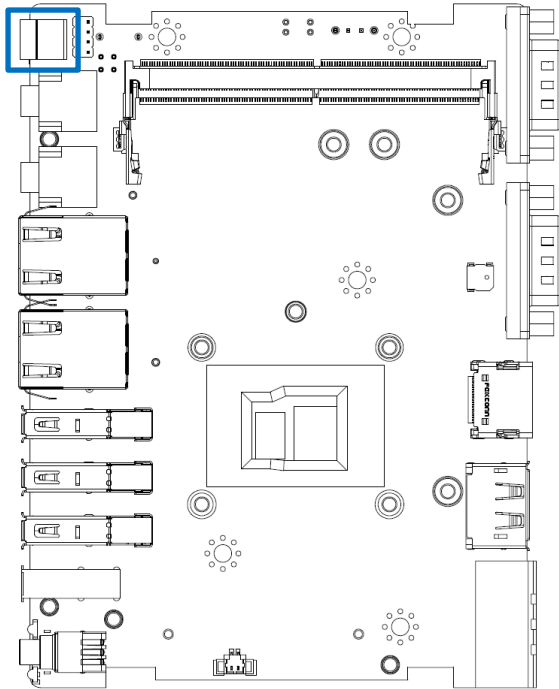

PWR_SW2

Connector Type: Terminal Block 1X2
 2-pin, 3.5mm pitch

Switch	Definition
1	Power Button
2	GND

2.3.4 DisplayPort Connector

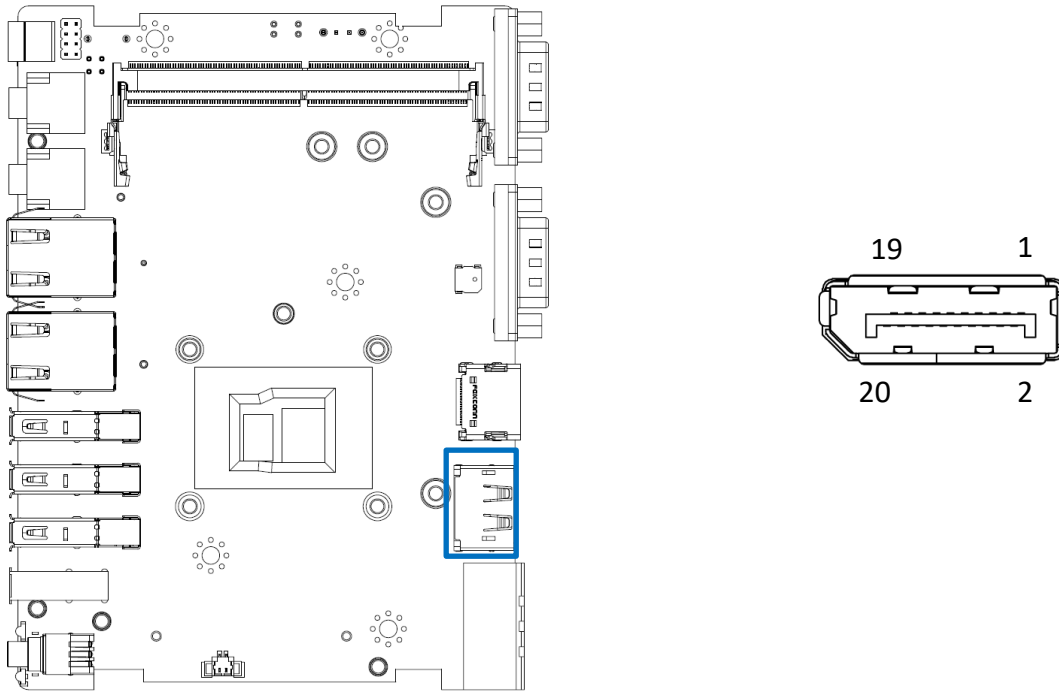

DP1

Pin	Definition	Pin	Definition
1	DP2_TXP0	11	GND
2	GND	12	DP2_TXN3
3	DP2_TXN0	13	DP2_CFG1
4	DP2_TXP1	14	GND
5	GND	15	DP2_AUX+
6	DP2_TXN1	16	GND
7	DP2_TXP2	17	DP2_AUX-
8	GND	18	DP2_HPD
9	DP2_TXN2	19	GND
10	DP2_TXP3	20	+V3.3S

2.3.5 HDMI Connector

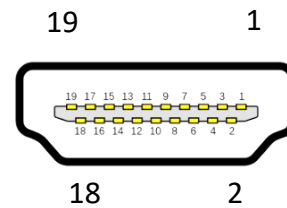
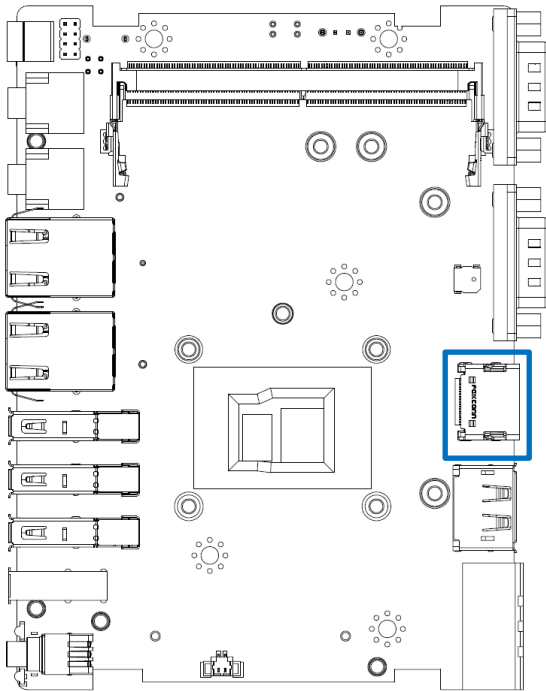

HDMI1

Pin	Definition	Pin	Definition
1	HDMI_TX2+_C	11	GND
2	GND	12	HDMI_TXC-_C
3	HDMI_TX2-_C	13	NC
4	HDMI_TX1+_C	14	NC
5	GND	15	HDMI_SCL
6	HDMI_TX1-_C	16	HDMI_SDA
7	HDMI_TX0+_C	17	GND
8	GND	18	+5V
9	HDMI_TX0-_C	19	HP_DET
10	HDMI_TXC+_C		

2.3.6 RS232 / RS422 / RS485 Connector

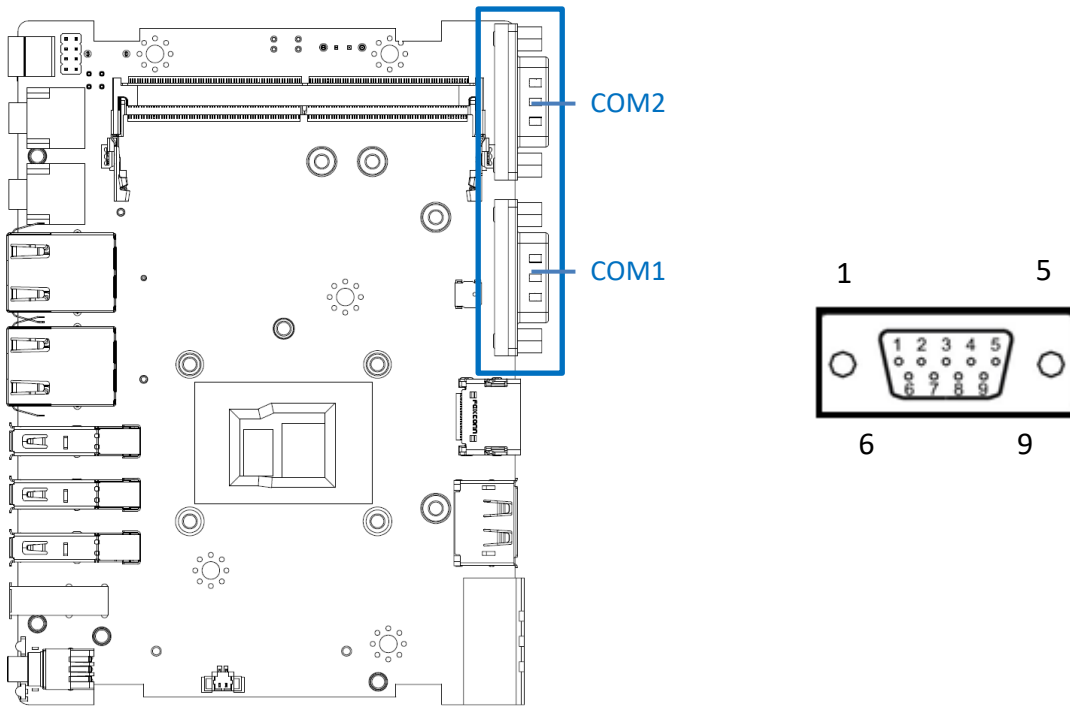

COM1-2

Connector Type: 9-pin D-Sub

Pin	RS232 Definition	RS422 / 485 Full Duplex Definition	ES485 Half Duplex Definition
1	DCD1/2	TX1/2-	DATA1/2-
2	RXD1/2	TX1/2+	DATA1/2+
3	TXD1/2	RX1/2+	
4	DTR1/2	RX1/2-	
5	GND		
6	DSR1/2		
7	RTS1/2		
8	CTS1/2		
9	RI1/2		

2.3.7 Smart FAN Connector

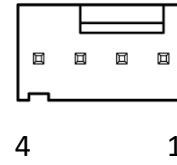
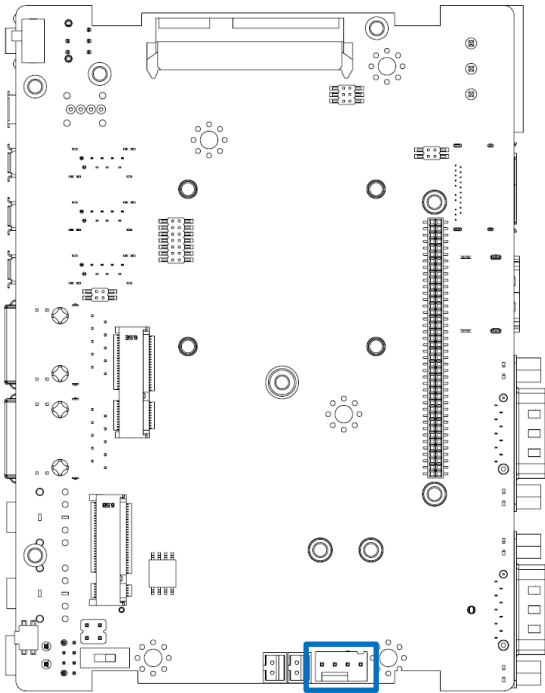

FAN1

Switch	Definition
1	GND
2	+12V
3	FANIN
4	FANCTL

2.3.8 CAN Bus Connector

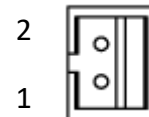
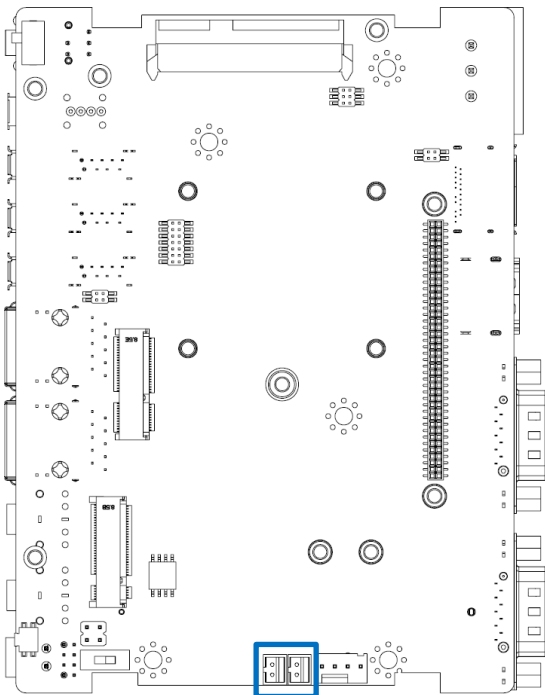

CAN1-2

Switch	Definition
1	CAN_L
2	CAN_H

2.3.9 USB2.0 Connector, Type A

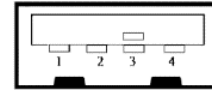
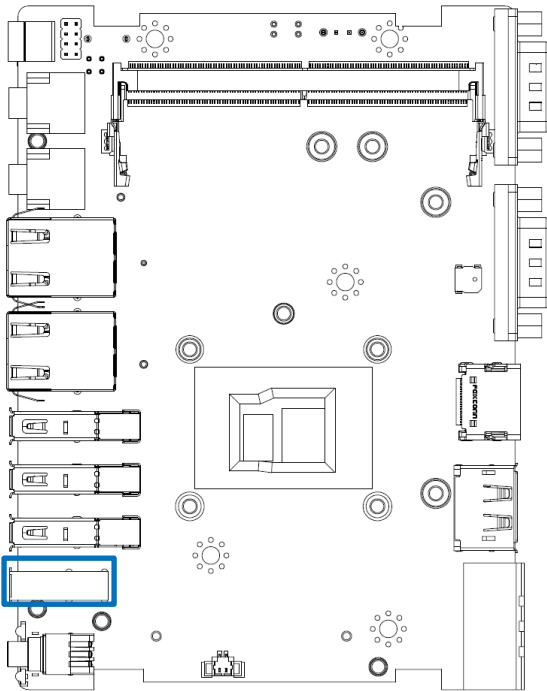

USB2_1

Switch	Definition
1	+5V
2	USB2_P4_N
3	USB2_P4_P
4	GND

2.3.10 USB 3.2 Connector, Type A

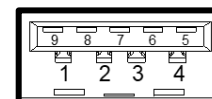
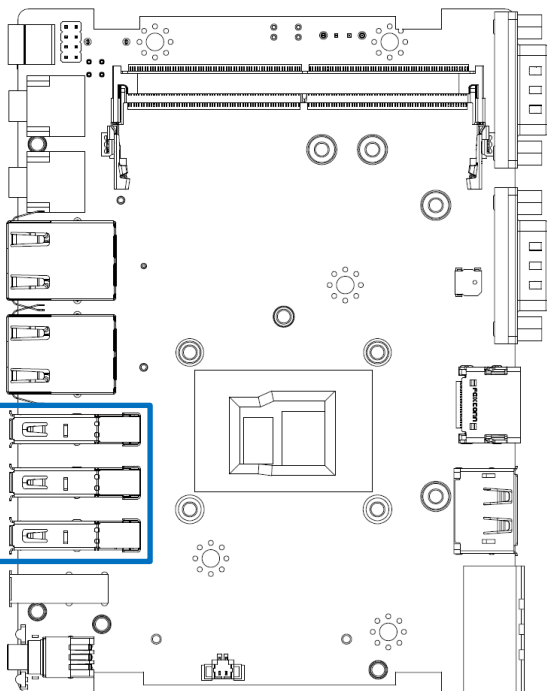

USB3_1-3

USB3_1
USB3_2
USB3_3

Pin	Definition	Pin	Definition
1	+5V	6	P1/2/3_SSRX_P
2	USB2_N	7	GND
3	USB2_P	8	P1/2/3_SSTX_N
4	GND	9	P1/2/3_SSTX_P
5	P1/2/3_SSRX_N		

2.3.11 RJ45 with LEDs Port

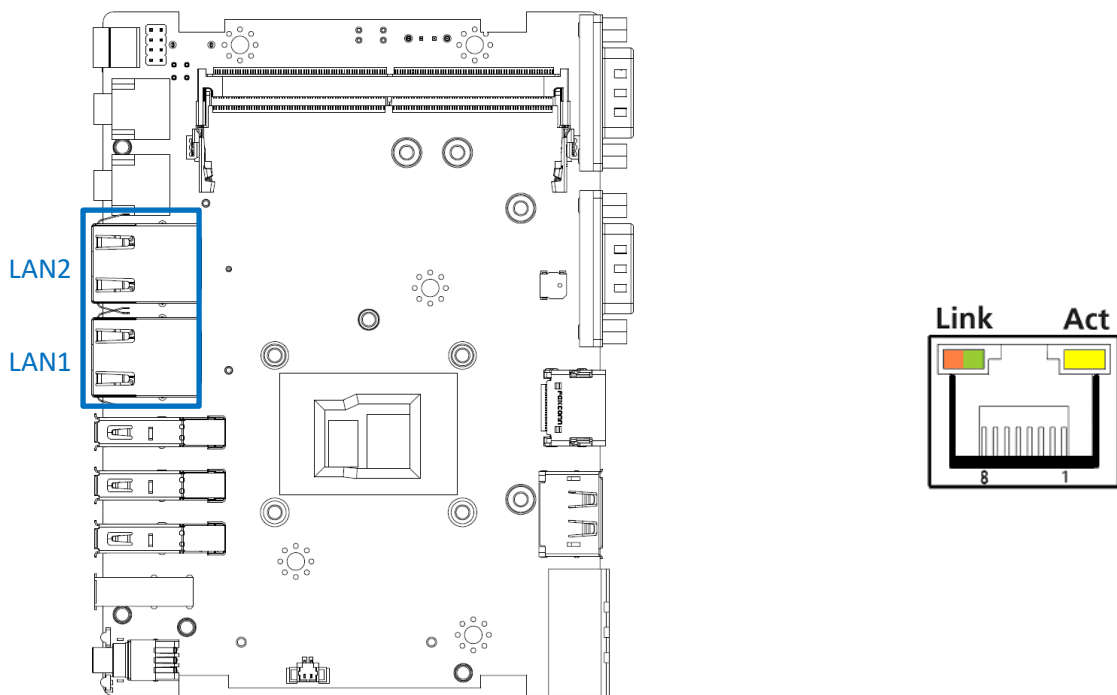

LAN1/2 (2.5GB)

Pin	Definition	Pin	Definition
1	LAN1/2_MDIO_P	7	LAN1/2_MDIO2_P
2	LAN1/2_MDIO_N	8	LAN1/2_MDIO2_N
3	LAN1/2_MDI1_P	9	LAN1/2_MDI3_P
4	LAN1/2_MDI1_N	10	LAN1/2_MDI3_N

Link LED Status	Definition	Act LRC Status	Definition
Steady Orange	1Gbps Network Link	Blinking Yellow	Data Activity
Steady Green	2.5Gbps Network Link	Off	No Activity
Off	10Gbps Network Link		

2.3.12 Microphone Jack

MIC_IN1

Connector Type: 5-pin Phone Jack

Pin	Definition
1	GND
2	MIC_R
3	NC
4	GND
5	MIC_L

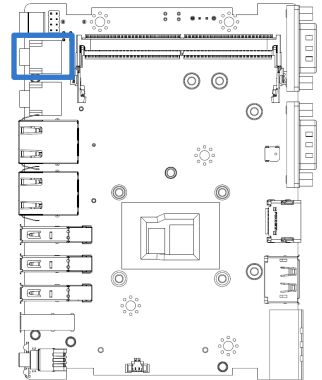

2.3.13 Line-out Jack

LINE_OUT1

Connector Type: 5-pin Phone Jack

Pin	Definition
1	GND
2	OUT_R
3	NC
4	GND
5	OUT_L

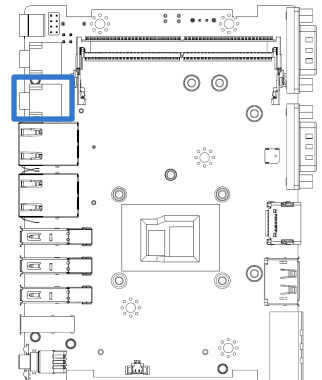

PWR_LED1: Power LED Status

Pin	Definition
1	Power LED+
2	Power LED-

HDD_LED1: HDD Access LED Status

Pin	Definition
1	HDD LED+
2	HDD LED-

2.3.14 AT/ATX Power Mode Switch

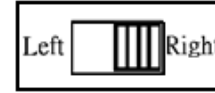
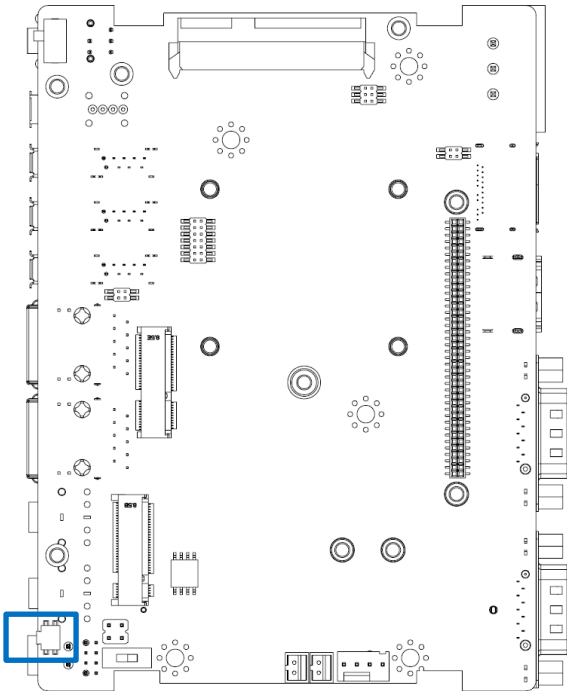

RESET1

Pin	Definition
1-2 (Right)	ATX Power Mode (Default)
2-3 (Left)	AT Power Mode

2.3.15 SATA with Power Connector

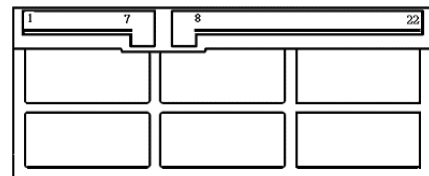
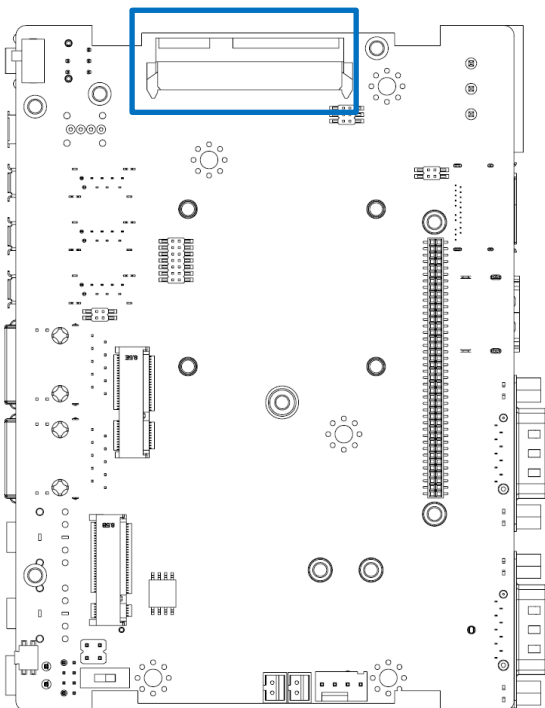

SATA1

Pin	Definition	Pin	Definition
1	GND	12	GND
2	SATA1_TXP	13	GND
3	SATA1_TN1	14	+5V
4	GND	15	+5V
5	SATA1-RXN	16	+5V
6	SATA1_RXP	17	GND
7	GND	18	GND
8	+3.3V	19	GND
9	+3.3V	20	+12V
10	+3.3V	21	+12V
11	GND	22	+12V

2.3.16 RTC_Battery

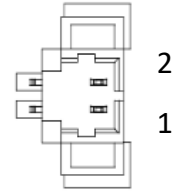
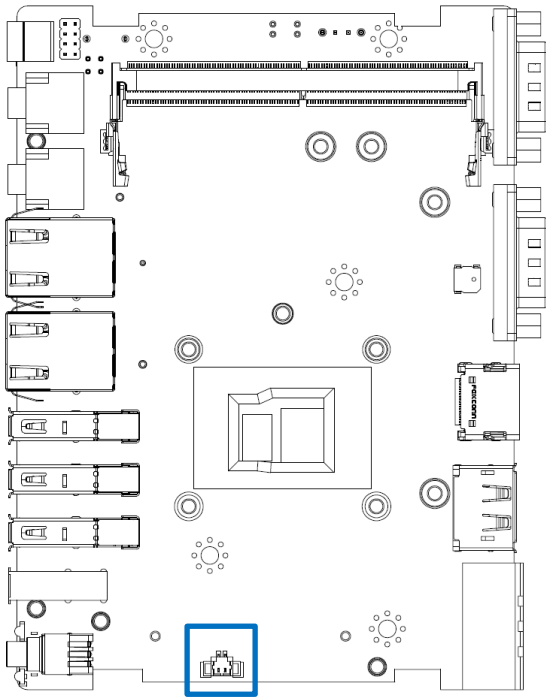

RESET1

Pin	Definition
1	Power+
2	GND

2.3.17 M.2 B Key Socket

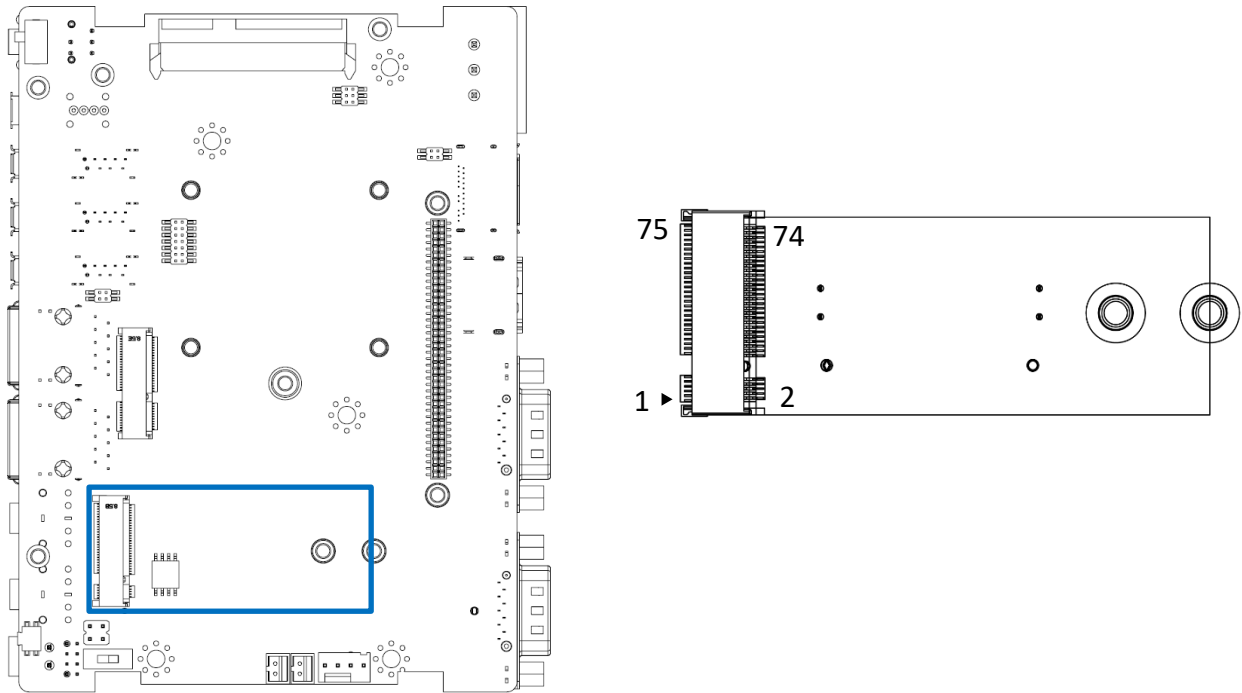

M2_KB1

Pin	Definition	Pin	Definition
1	+3.3V	2	+3.3V
3	GND	4	+3.3V
5	GND	6	+3.3V
7	USB2_D+	8	+3.3V
9	USB2_D-	10	NC
11	GND		
21	+3.3V	20	NC
23	NC	22	NC
25	NC	24	NC
27	GND	26	NC
29	USB3_RXN0	28	NC
31	USB3_RXP0	30	PSIM_RST
33	GND	32	PSIM_CLK
35	USB3_TXN0	34	PSIM_DATA
37	USB3_TXP0	36	PSIM_PWR
39	GND	38	NC
41	PCIe_RXP0(SATA)	40	NC
43	PCIe_RXN0(SATA)	42	SSIM_DATA
45	GND	44	SSIM_CLK
47	PCIe_TXN0	46	SSIM_RST
49	PCIe_TXP0	48	SSIM_PWR
51	GND	50	PCIe_RST#
53	REFCLK1-	52	CLK_REQ#

Pin	Definition	Pin	Definition
55	REFCLK1+	54	NC
57	GND	56	NC
59	NC	58	NC
61	NC	60	NC
63	NC	62	NC
65	NC	64	NC
67	NC	66	NC
69	+3.3V	68	NC
71	GND	70	+3.3V
73	GND	72	+3.3V
75	+3.3V	74	+3.3V

2.3.18 M.2 E Key Socket

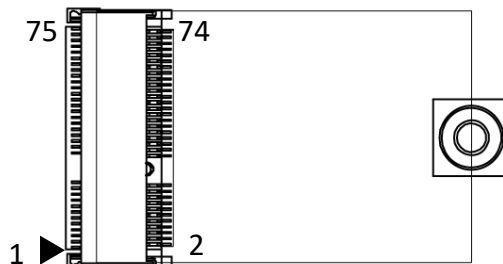
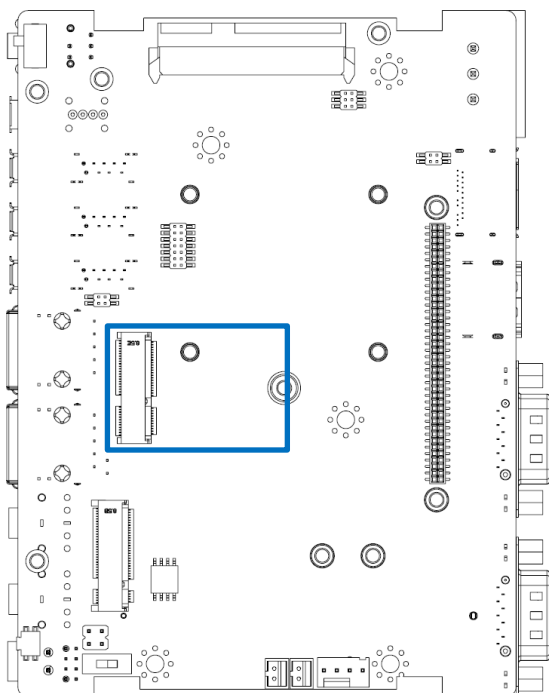

M2_KE1

Pin	Definition	Pin	Definition
1	GND	2	+3.3V
3	USB2_D+	4	+3.3V
5	USB2_D-	6	NC
7	GND	8	NC
9	NC	10	NC
11	NC	12	NC
13	GND	14	NC
15	NC	16	NC
17	NC	18	GND
19	GND	20	NC
21	NC	22	NC
23	NC		
33	GND	32	NC
35	PETP0	34	NC
37	PETN0	36	NC
39	GND	38	CLINK_RESRT
41	PERP0	40	CLINK_DATA
43	PERN0	42	CLINK_CLK
45	GND	44	NC
47	REFCLKP0	46	NC
49	REFCLKN0	48	NC

Pin	Definition	Pin	Definition
51	GND	50	SCSCLK_32KHz
53	CHKREQ0#	52	PERST#
55	PEWAKE0#	54	NC
57	GND	56	NC
59	NC	58	NC
61	NC	60	NC
63	GND	62	NC
65	NC	64	NC
67	NC	66	NC
69	GND	68	NC
71	NC	70	PEWAKE1#
73	NC	72	+3.3V
75	GND	74	+3.3V

2.3.19 CLR_COMS

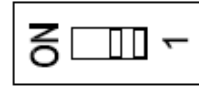
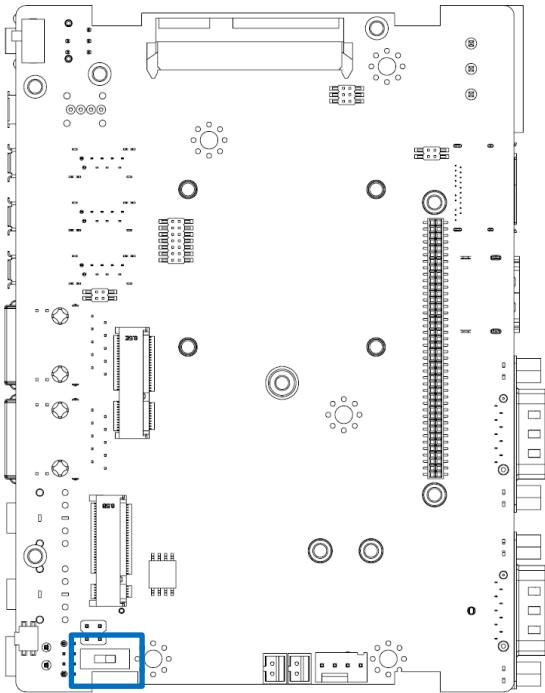

Pin	Definition
1	Default
ON	Clear COMS

Chapter 3

System Setup

3.1 Set torque force to 3.5 kgf-cm to execute all the screwing and unscrewing.

3.2 Removing chassis bottom cover

**WARNING**

In order to prevent electric shock or system damage, before removing the chassis cover, must turn off power and disconnect the unit from power source.

1. Place the system faced upside down and unscrew the 6 screws (M3x5L) on the bottom cover.

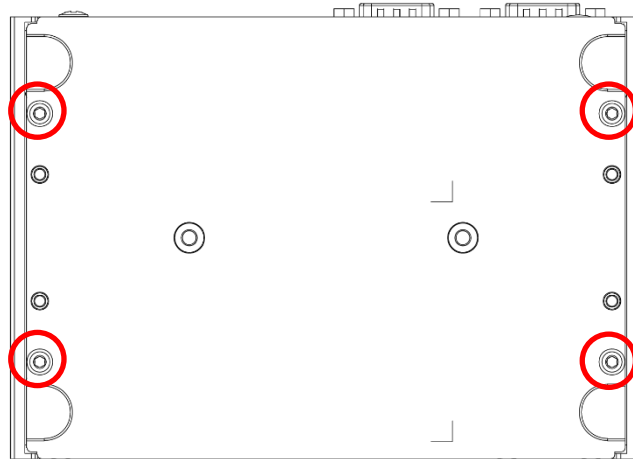

2. Now you can remove the bottom cover.

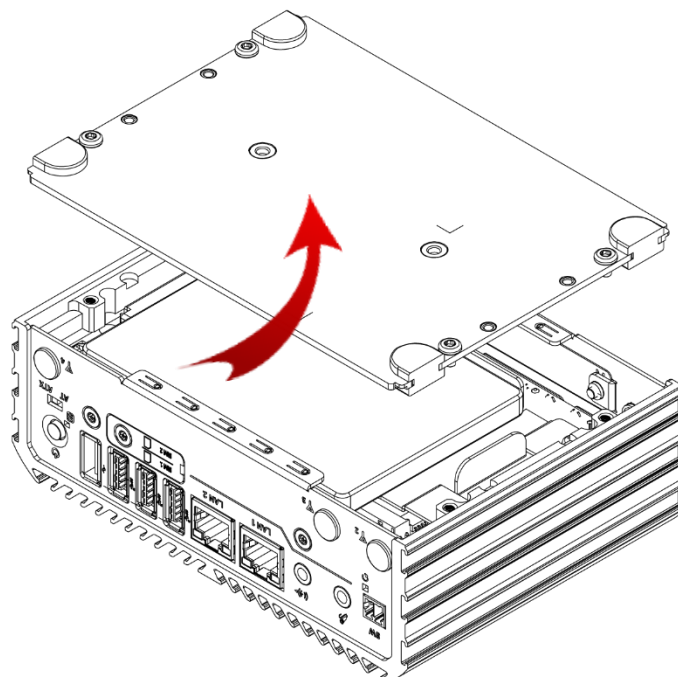

3.3 Removing HDD bracket

3.3.1 RCO-1000-ASL-10 Series

1. Unscrew four screws (M3x5L) circled below.

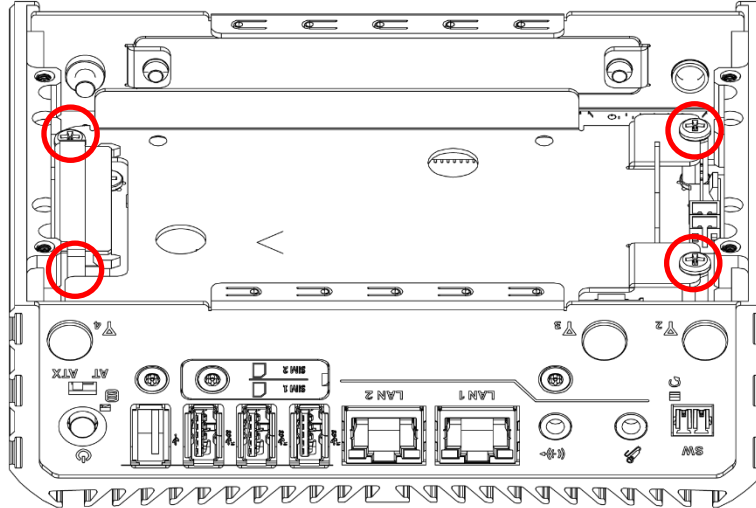

2. Now you can remove the HDD bracket.

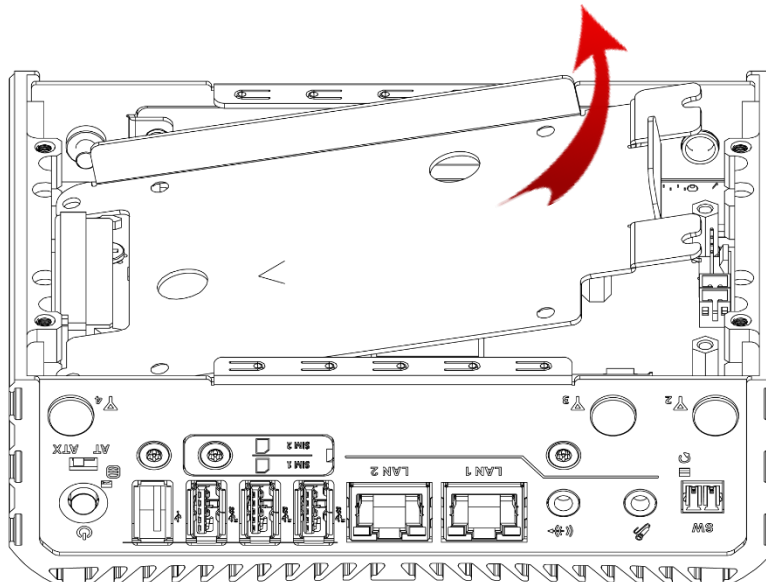

3.3.2 RCO-1000-ASL-20 & RCO-1000-ASL-30 Series

Removing chassis bottom cover

1. Place the system faced upside down and unscrew the 6 screws (M3x5L) on the bottom cover.

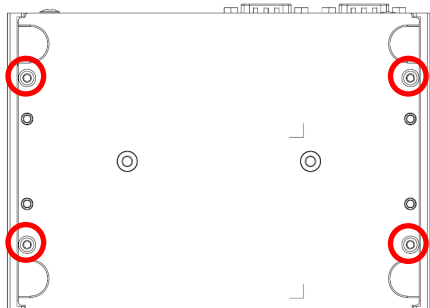

2. Now you can remove the bottom cover.

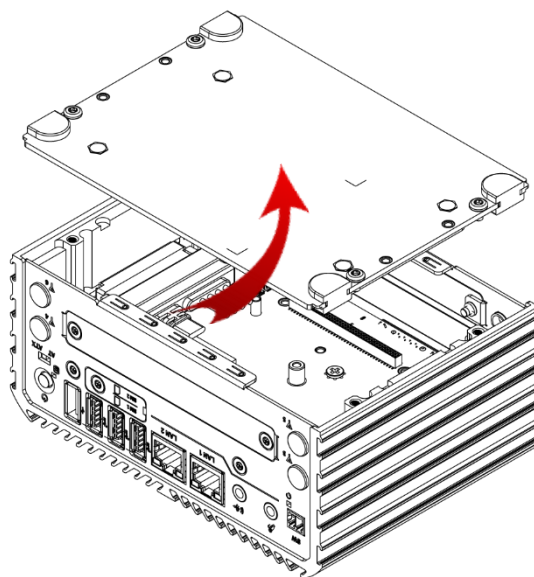

3. Flip the bottom plate over and remove the four screws (M3x5L) circled below.

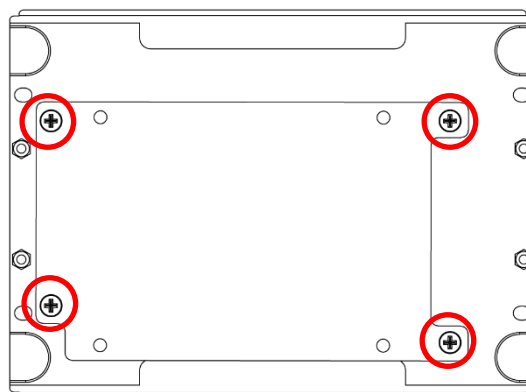
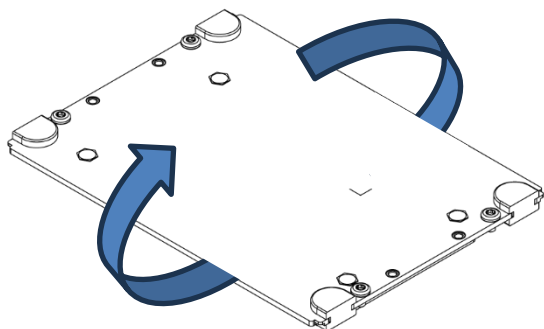

4. Now you can remove the HDD bracket.

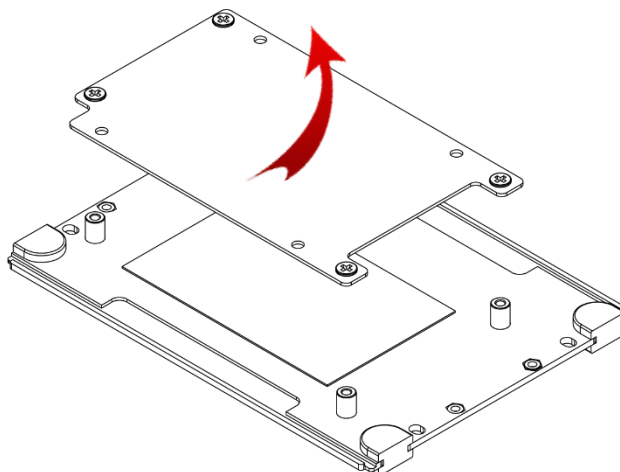

3.4 Removing chassis top cover

1. Unscrew the three screws (M3x5L) and two copper stud (M3x11L) highlighted below.

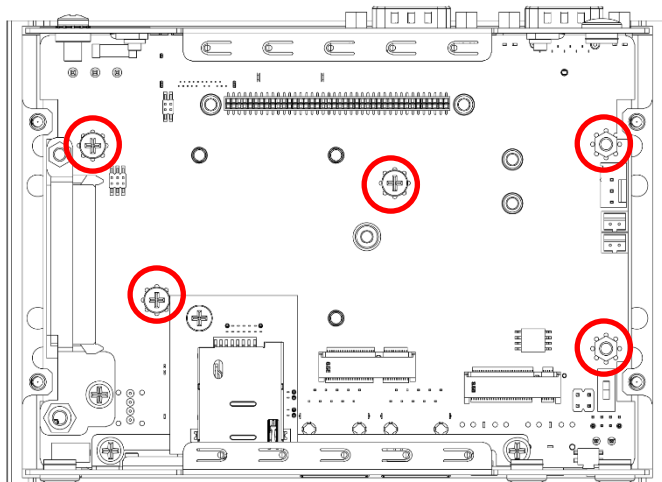

2. Hold the body of the system and lift it vertically away from the top cover.

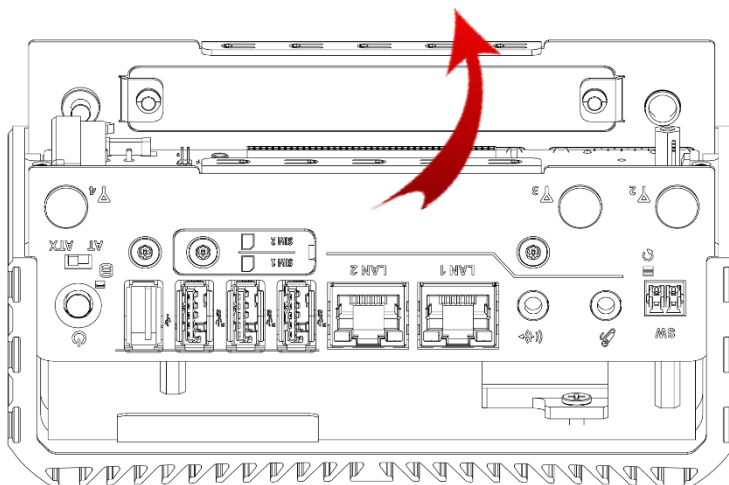

3. Top cover separated from the system body.

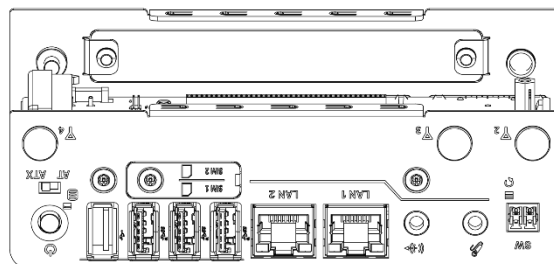
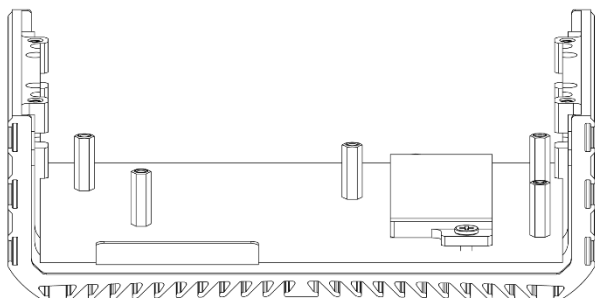

3.5 Installing SODIMM

Place the system body with SODIMM socket facing upward.

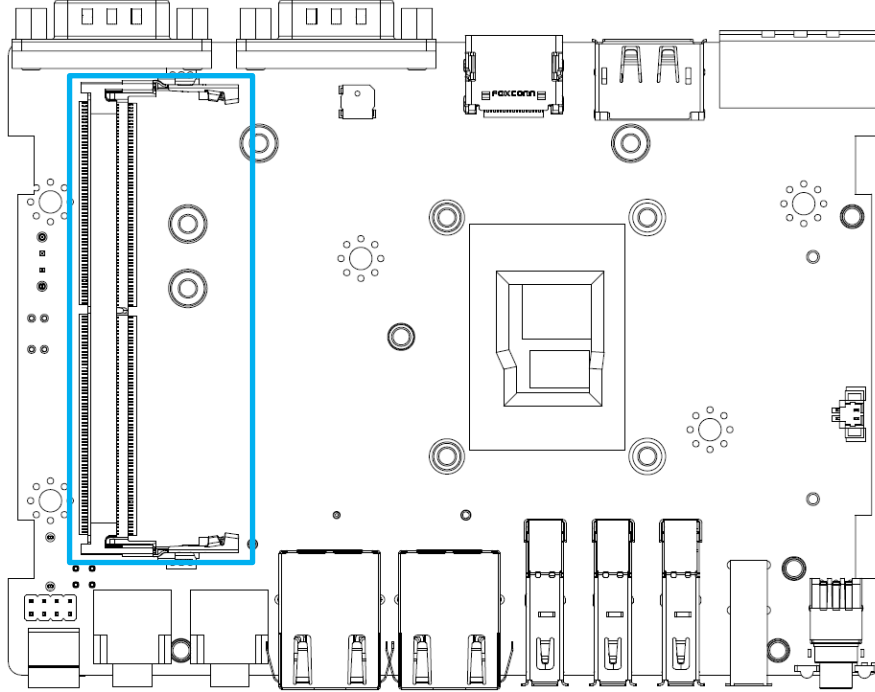

Install SO-DIMM Step by Step

1. Gently pull the locking tabs on either side of the SO-DIMM slot. Insert the SO-DIMM module at a 30~45-degree angle.

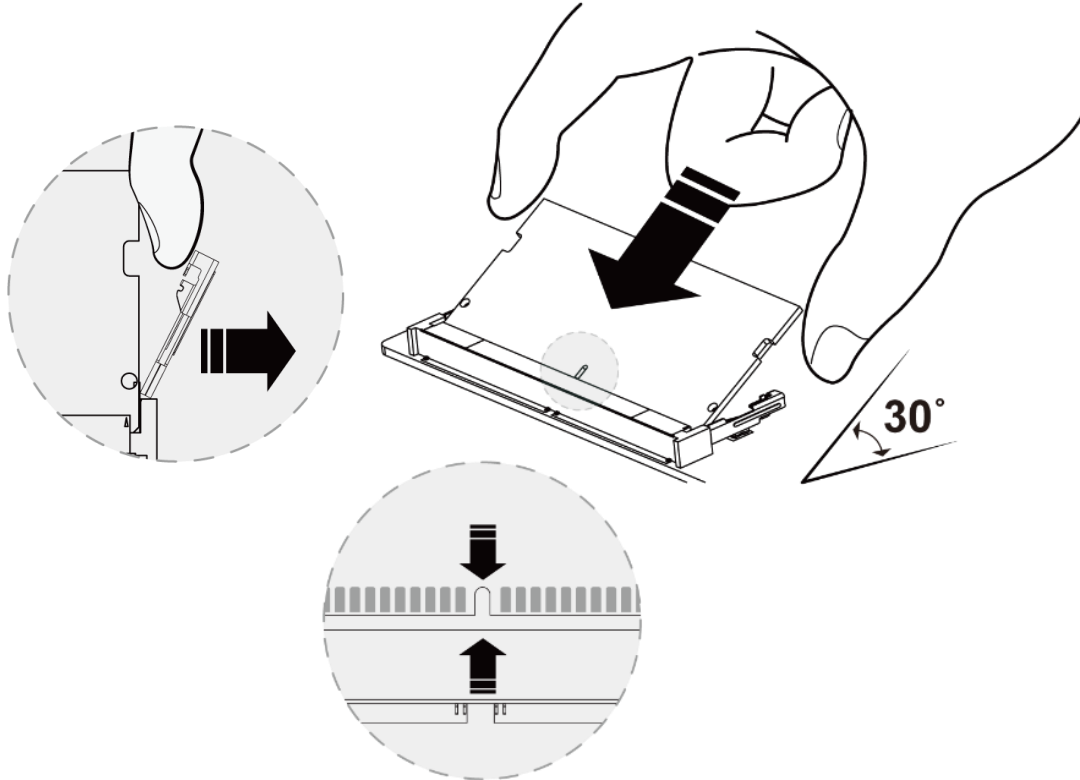

2. Press down gently until you hear a "click" sound and the tabs lock it into place.

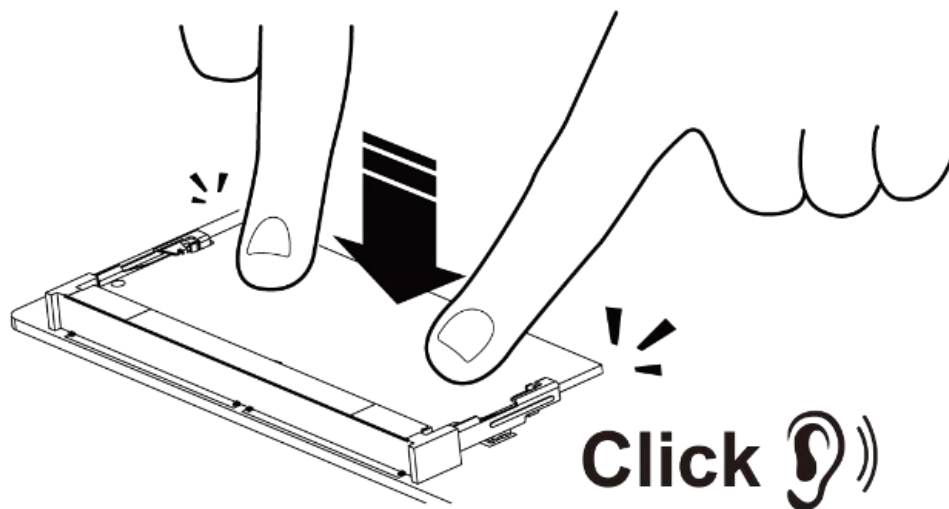

3.6 Installing Wi-Fi Module and Antenna

The M.2 E-Key supports Wi-Fi module, , as highlighted in the picture below.

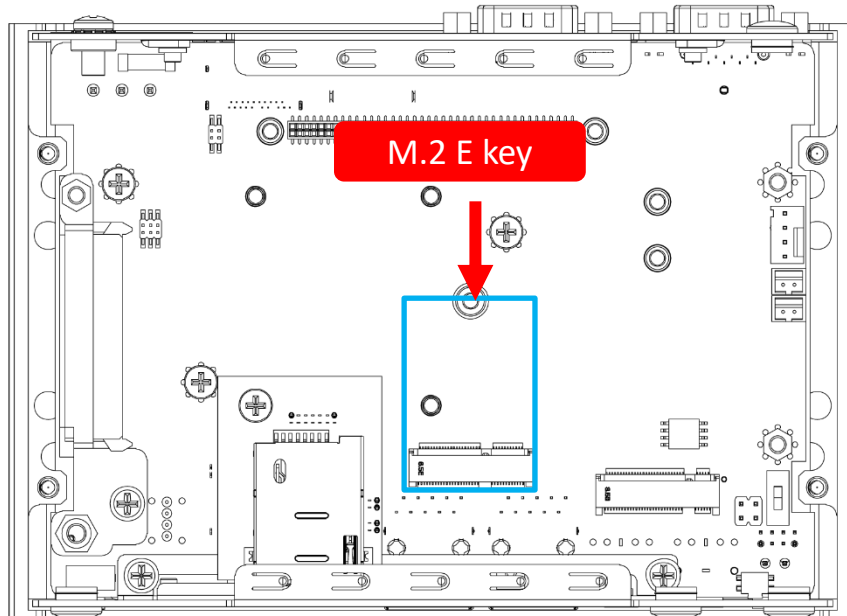

1. Connect the SMA cables to the Wi-Fi module.

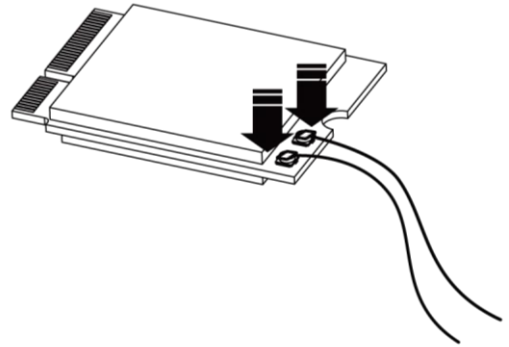

2. Insert the Wi-Fi module at a 45-degree angle.

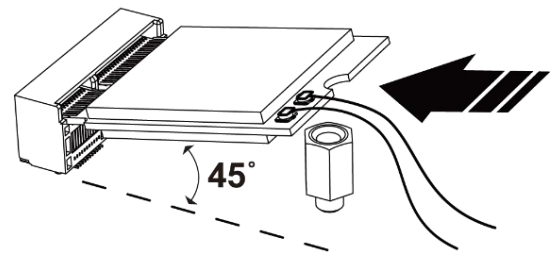

3. Press the Wi-Fi module down and secure it with one screw.

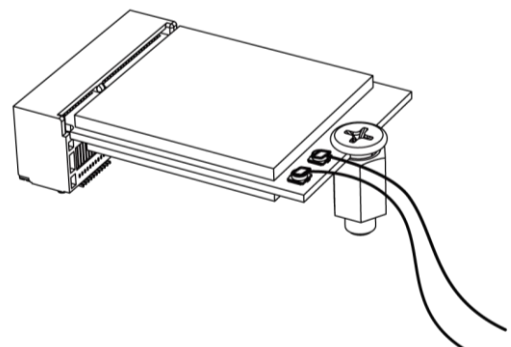
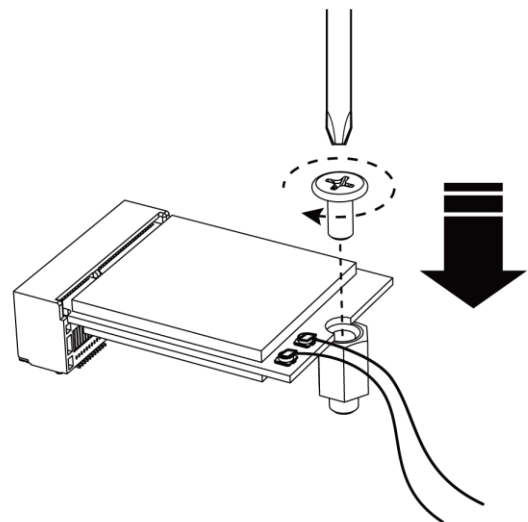

- 4. Attach the external antenna to the SMA jack by securely threading them together.

Attach the cable end of the wireless RF connector to the communication module.

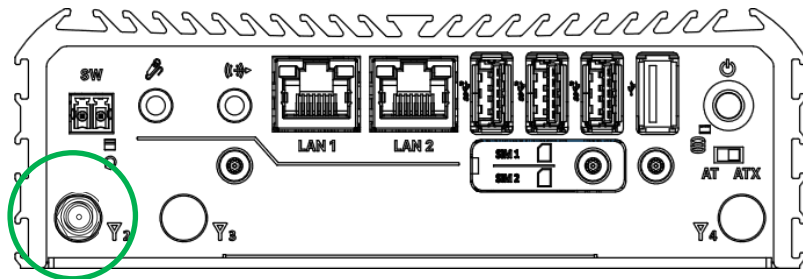

Assemble the antenna and SMA jack together

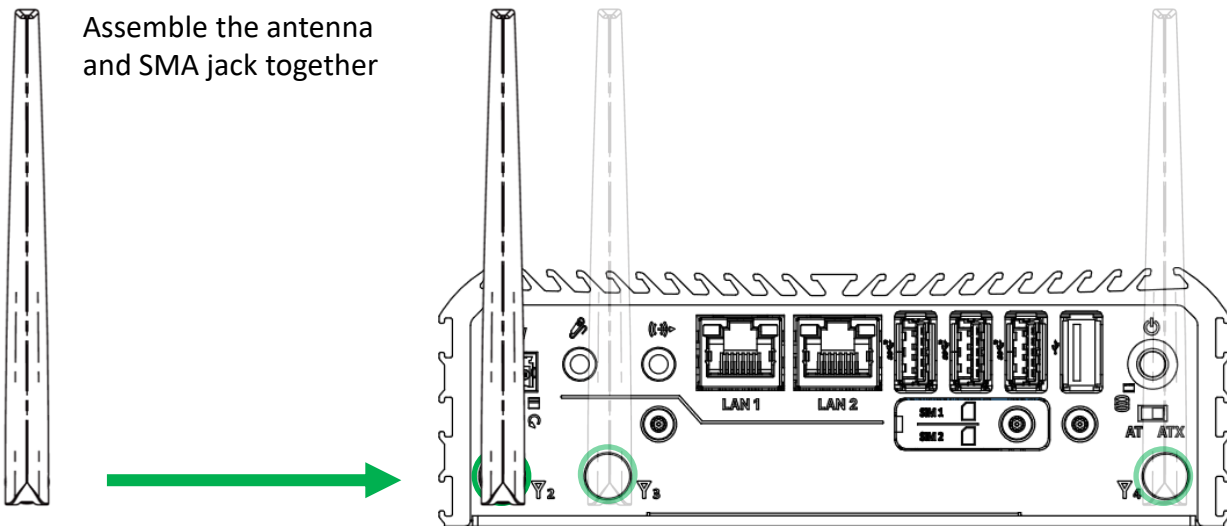

3.7 Installing Communication Module and Antenna

The M.2 B-Key supports communication module, as highlighted in the picture below.

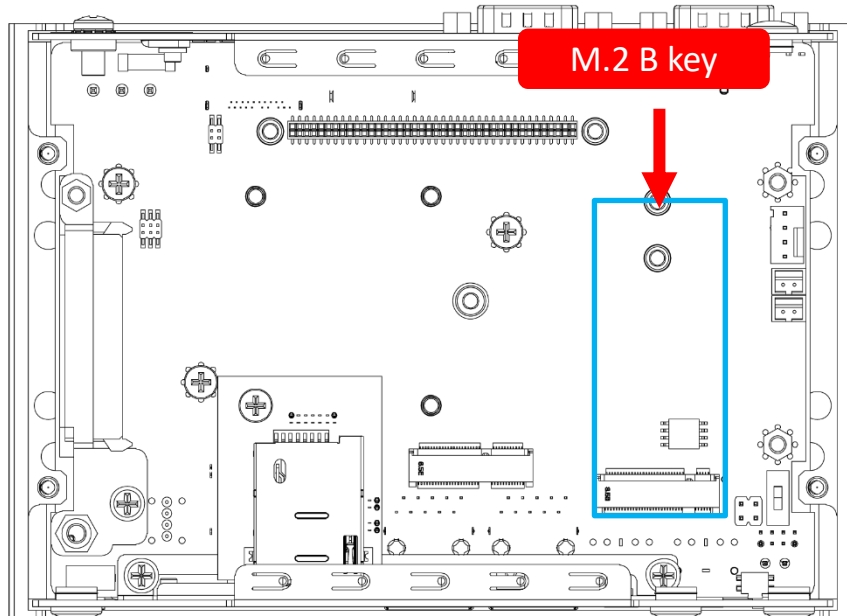

Install M.2 B Key module Step by Step

1. Connect the SMA cables to the communication module.

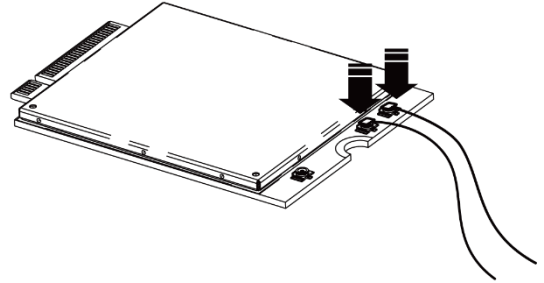

2. Insert the communication module at a 45-degree angle.

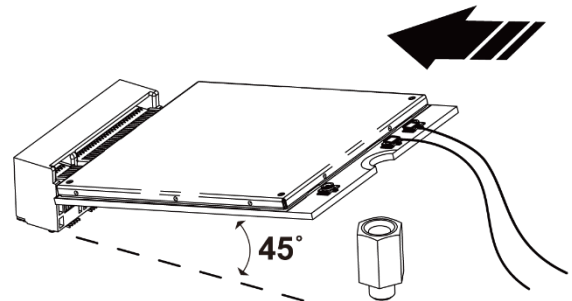

3. Press the communication module down and secure it with one screw.

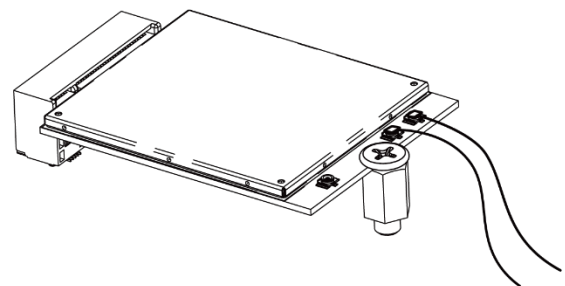
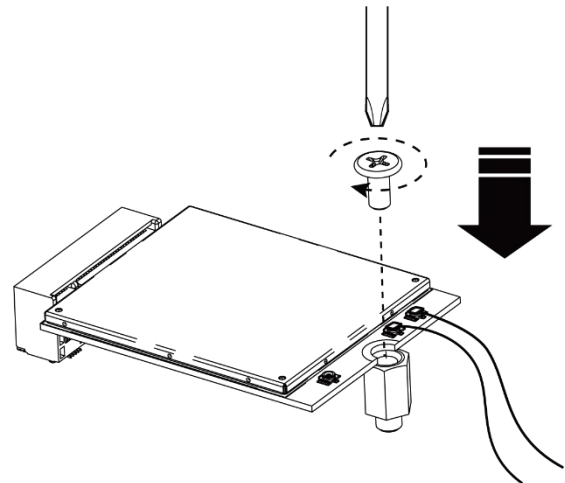

- 4. Assemble the antenna and SMA jack together; the outcome should resemble the picture below.

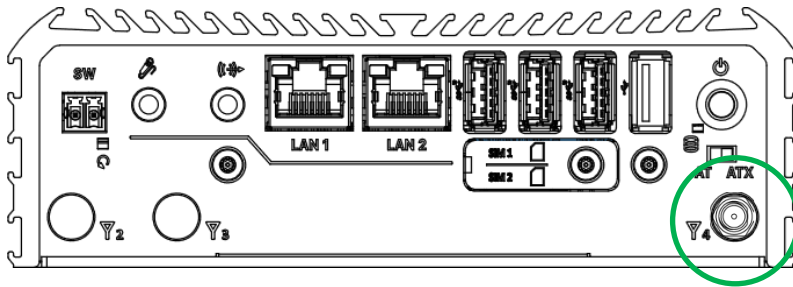

Attach the cable end of the wireless RF connector to the communication module.

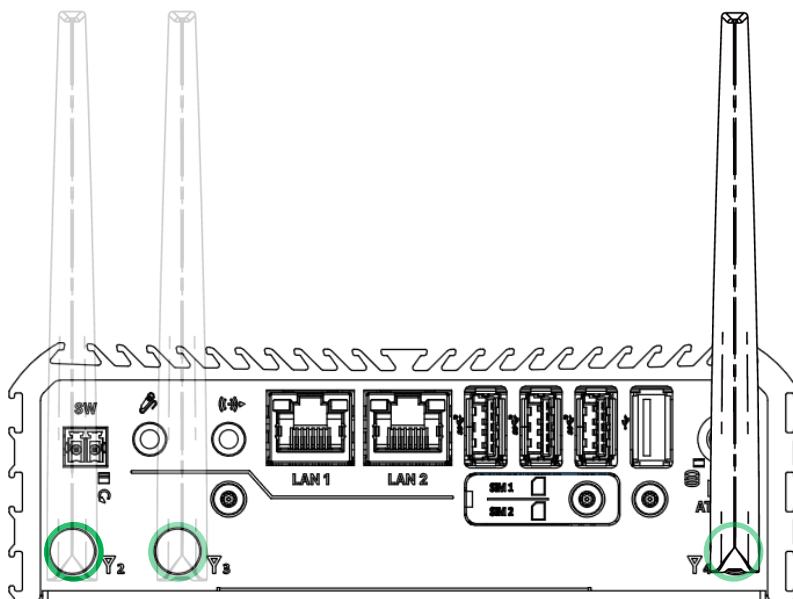

Assemble the antenna and SMA jack together

3.8 Installing SIM card

SIM card socket is located on the front panel of the system. Unscrew one screw (M3x5L) to remove the SIM card socket cover.

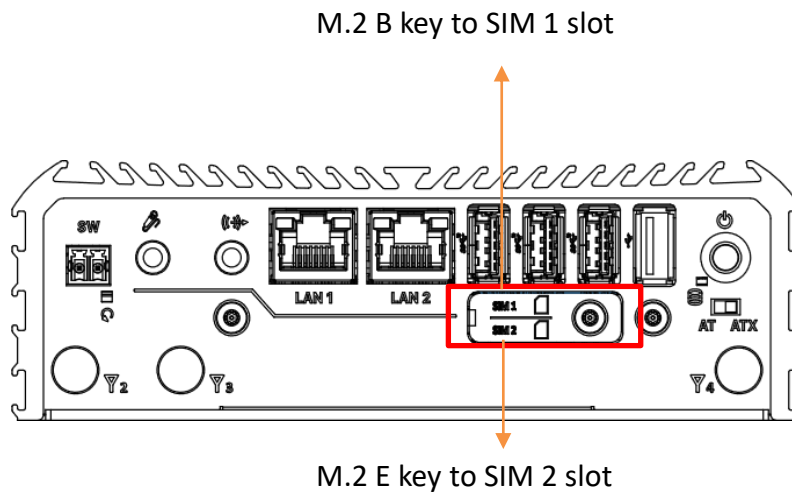

SIM Card Socket Number	Matching Slot
SIM 1	M.2 B key
SIM 2	M.2 E key

3.9 Installing Wall Mount

1. Wall Mount holder is available for RCO-1000-ASL series.

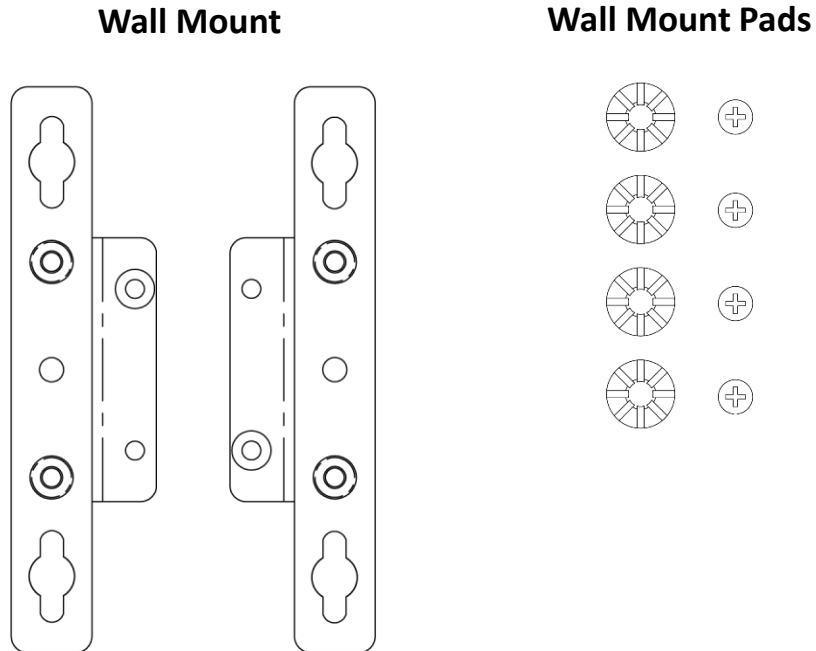

2. Assemble the anti-vibration grommets and screws together.

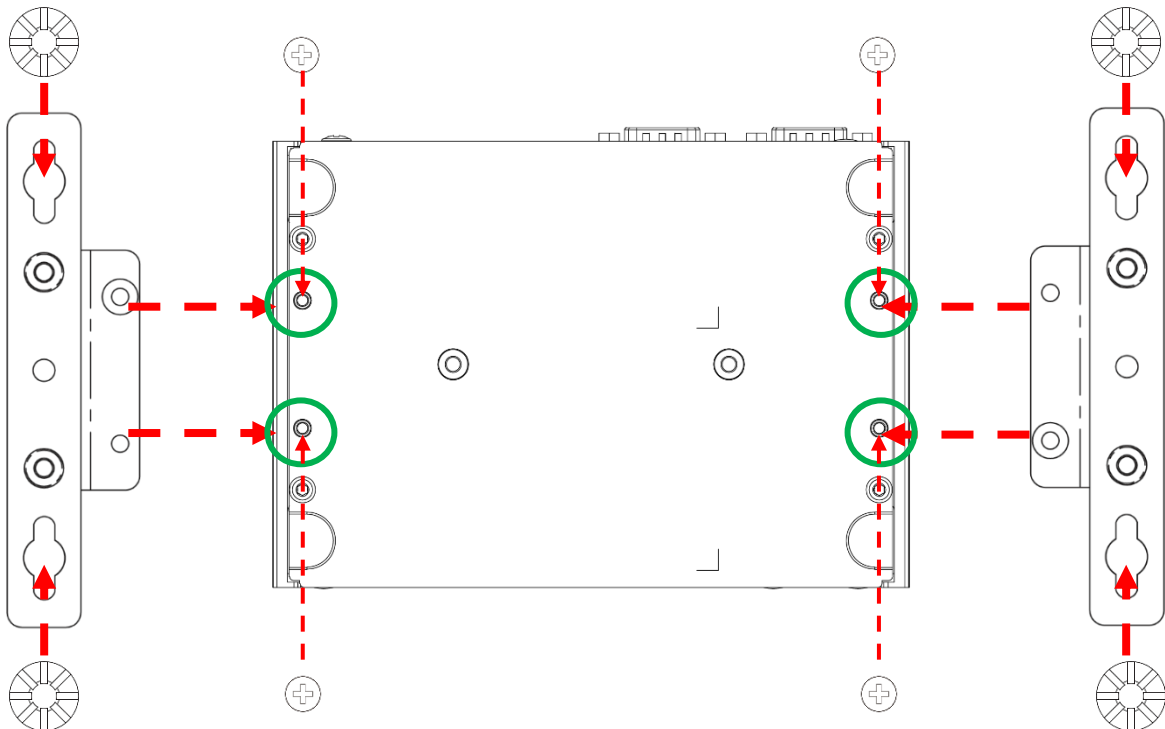

3.10 Installing VESA mount kit

1. VESA mount kit is available for RCO-1000 series as optional accessories.

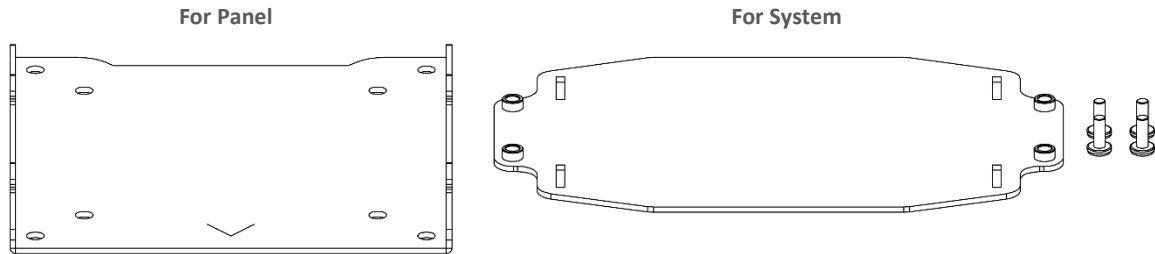

2. Place the system upside down so you can see the bottom cover. The highlighted screw holes below will be used.

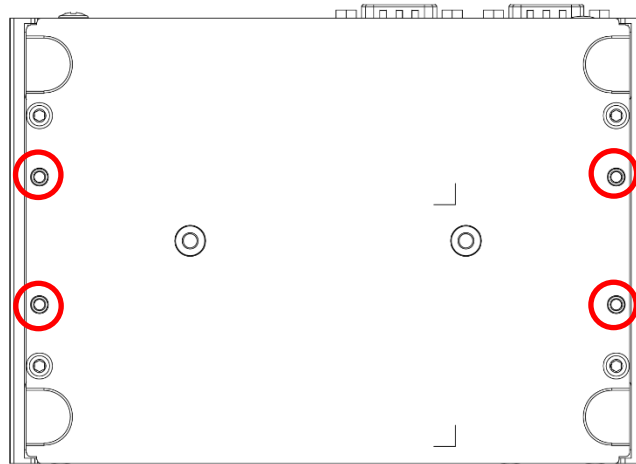

3. Place the VESA mount kit (for system) on top of the system aligning the matching screw holes.

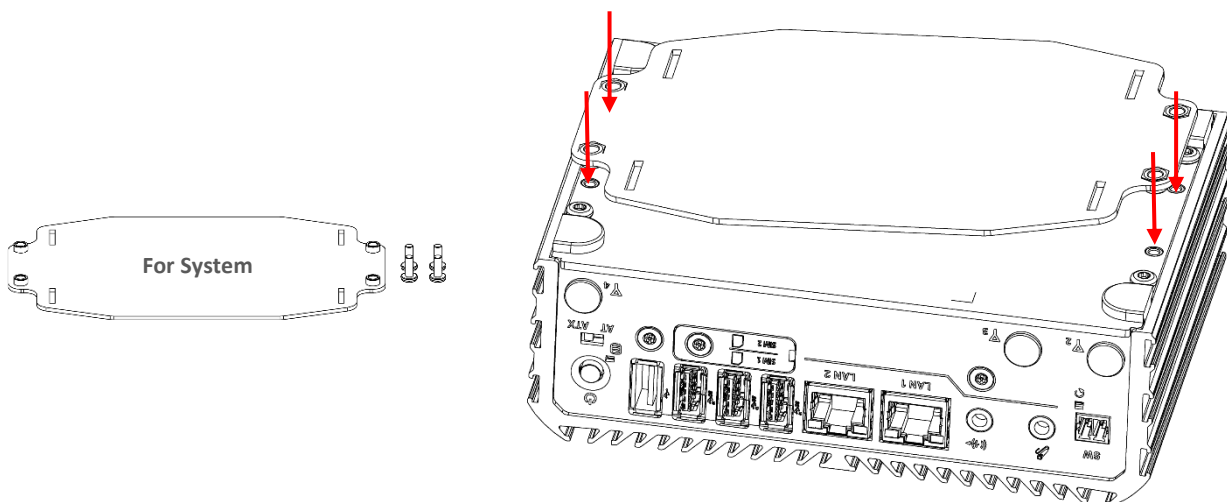

5. VESA mount kit (for panel) should be locked on the back of the panel with four screws.

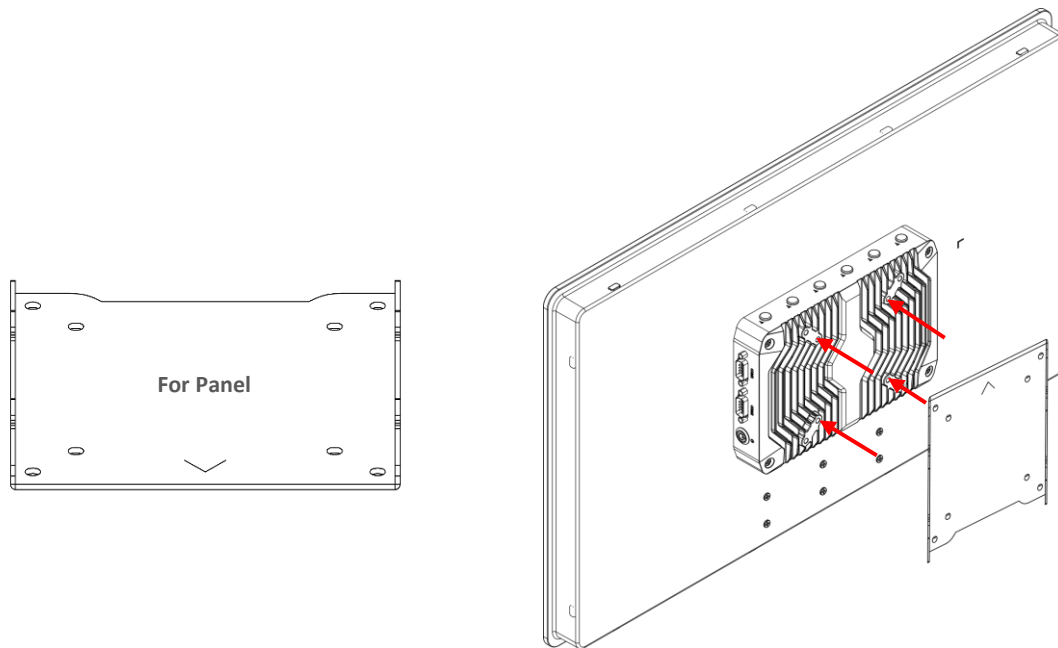

6. Now the system can be hang in the back of the panel using the hooks.

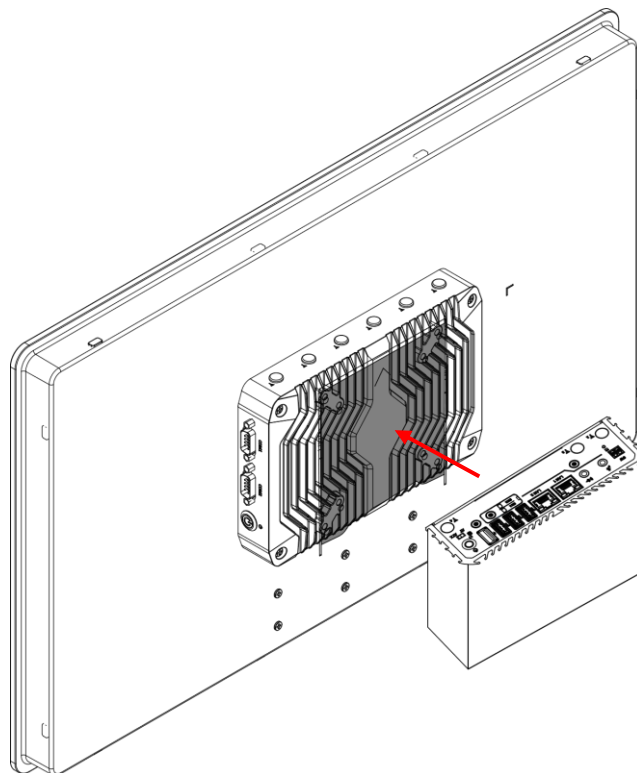

3.11 Installing side mount kit

1. Side mount kit is available for RCO-1000 series as optional accessories.

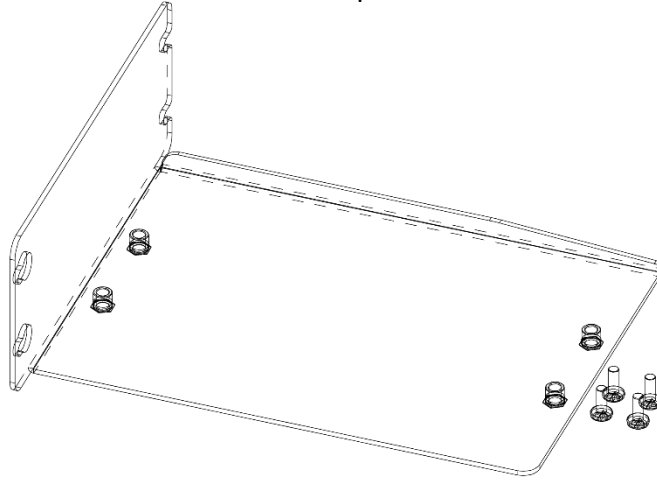

2. Place the system upside down so you can see the bottom cover. The highlighted screw holes below will be used.

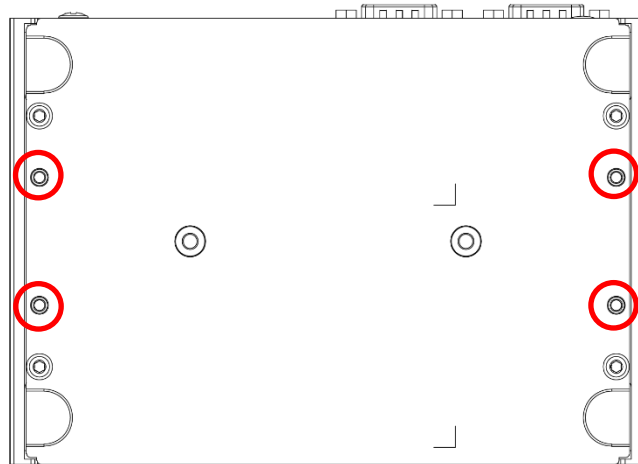

3. Place the side mount kit on top of the system aligning the matching screw holes.

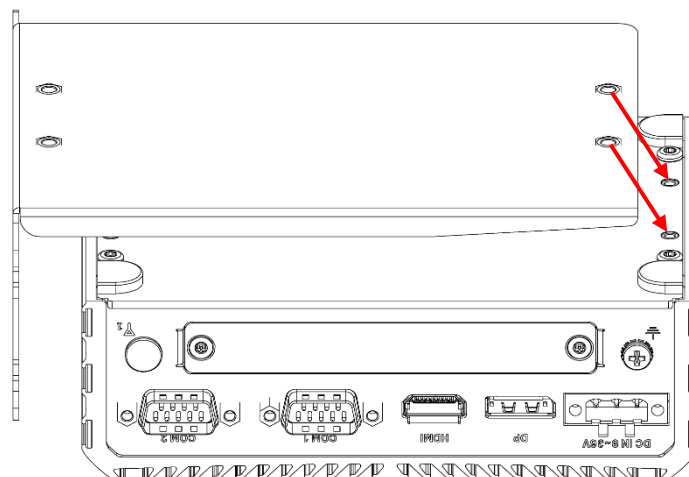

3.12 Installing DIN Rail Holder

1. Din Rail holder is available for RCO-1000 series.

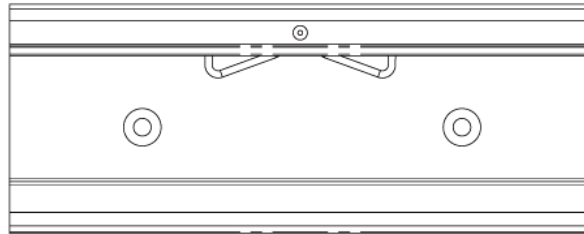

(M4x5L, Nylok).

(3-DINR-0004) DinRail-2MountingKit

2. Place Din rail holder on the back of computer and secure it with four screws.

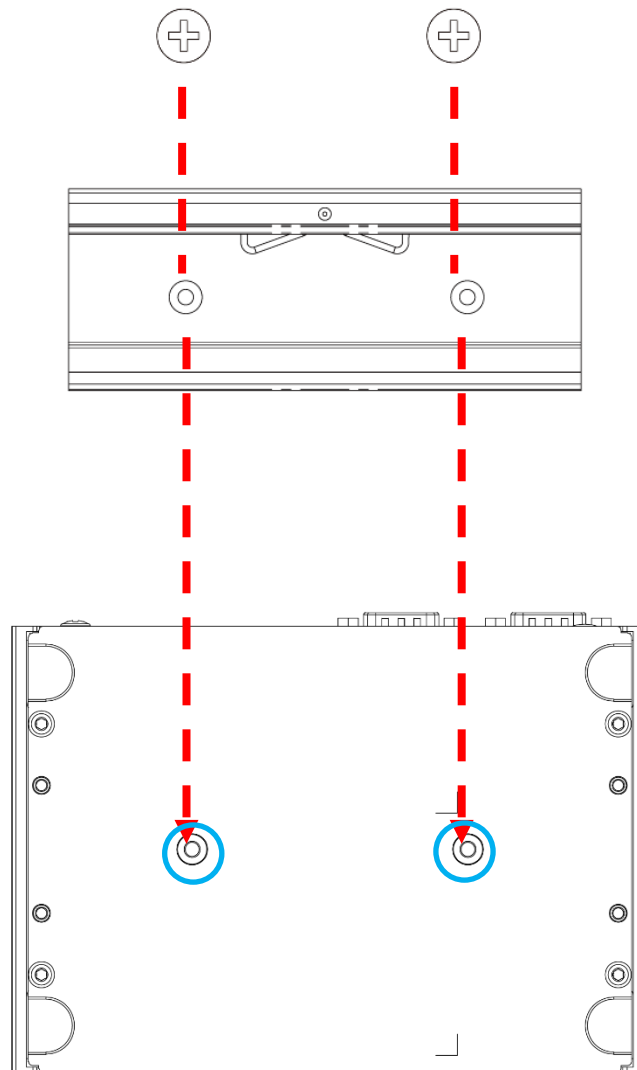

Chapter 4

BIOS Setup

4.1 BIOS Introduction

The BIOS provides an interface to modify the configuration. When the battery is removed, all the parameters will be reset.

BIOS Setup

Power on the embedded system and by pressing immediately allows you to enter the setup screens. If the message disappears before you respond and you still wish to enter the Setup, restart the system by turning it OFF and ON or pressing the RESET button.

You may also restart the system by simultaneously pressing <Ctrl>, <Alt>, and <Delete> keys.

Control Keys	
<→> <←>	Select Screen
<↑> <↓>	Select Item
<Enter>	Select
<Page Up/+>	Increases the numeric value or makes changes
<Page Down/->	Decreases the numeric value or makes changes
<F1>	General Help
<F2>	Previous Value
<F3>	Load Optimized Defaults
<F4>	Save Configuration and Exit
<Tab>	Select Setup Fields
<Esc>	Exit BIOS Setup

Main Setup

The main menu lists the setup functions you can make changes to. You can use the arrow keys (↑↓) to select the item. The on-line description of the highlighted setup function is displayed at the bottom of the screen.

General Help <F1>

The BIOS setup program provides a General Help screen. You can call up this screen from any menu by simply pressing <F1>. The Help screen lists the appropriate keys to use and the possible selections for the highlighted item. Press <Esc> to exit the Help screen.

4.2 Main Setup

Press to enter BIOS CMOS Setup Utility. The Main setup screen is showed as following when the setup utility is entered. System Date/Time is set up in the Main Menu.

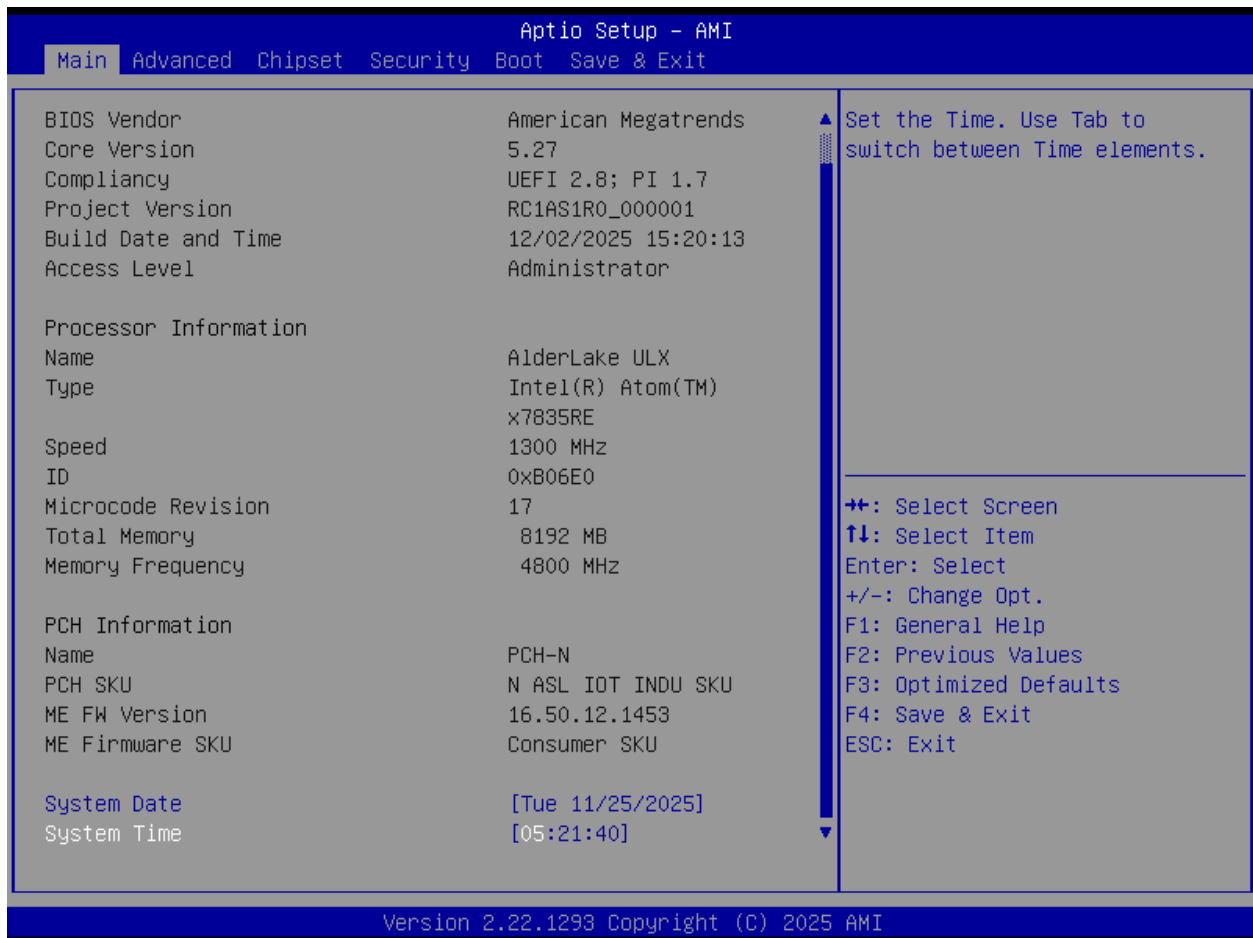

■ System Date

Set the system date. Please use <Tab> to switch between data elements.

■ System Time

Set the system time. Please use <Tab> to switch between time elements.

4.3 Advanced Setup

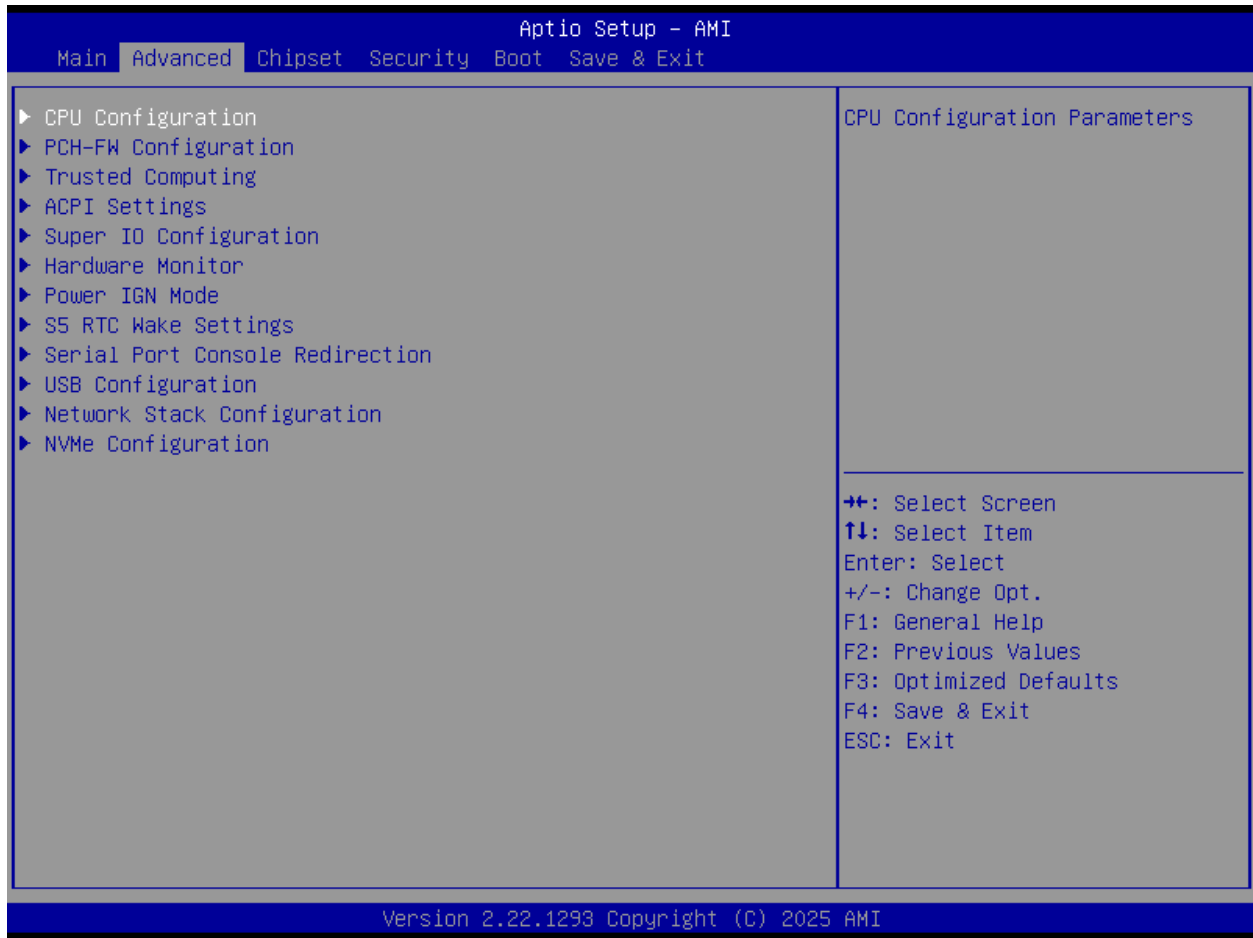

4.3.1 CPU Configuration

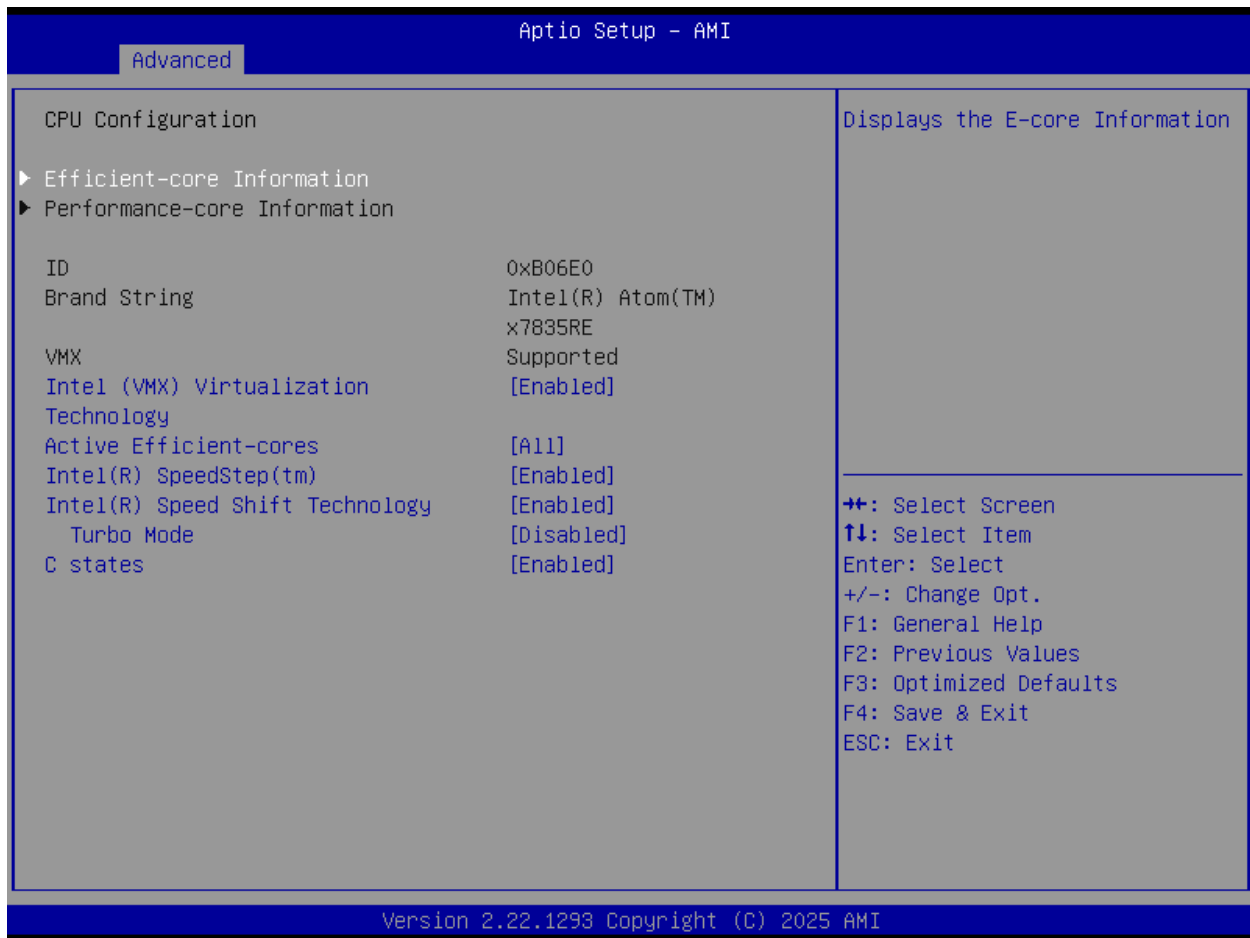

Item	Options	Description
Intel (VMX) Virtualization Technology	Disabled, Enabled[Default]	When enabled, a VMM can utilize the additional hardware capabilities provided by Virtualization Technology.
Active Processor Cores	All[Default] 0 1 2 3	Number of cores to enable in each processor package.
Intel® SpeedStep™	Disabled, Enabled[Default]	Allows more than two frequency ranges to be supported.
Intel® Speed Shift Technology	Disabled, Enabled[Default]	Enable/Disable Intel® Speed Shift Technology support. Enabling will expose the CPPC v2 interface to allow for hardware controlled P-states.
Turbo Mode	Disabled[Default], Enabled	Enable/Disable processor Turbo Mode (requires EMTTM enabled too). AUTO means enabled.
C states	Disabled, Enabled[Default]	Enable/Disable CPU Power Management. Allows CPU to go to C states when it's not 100% utilized.

Efficient-core Information

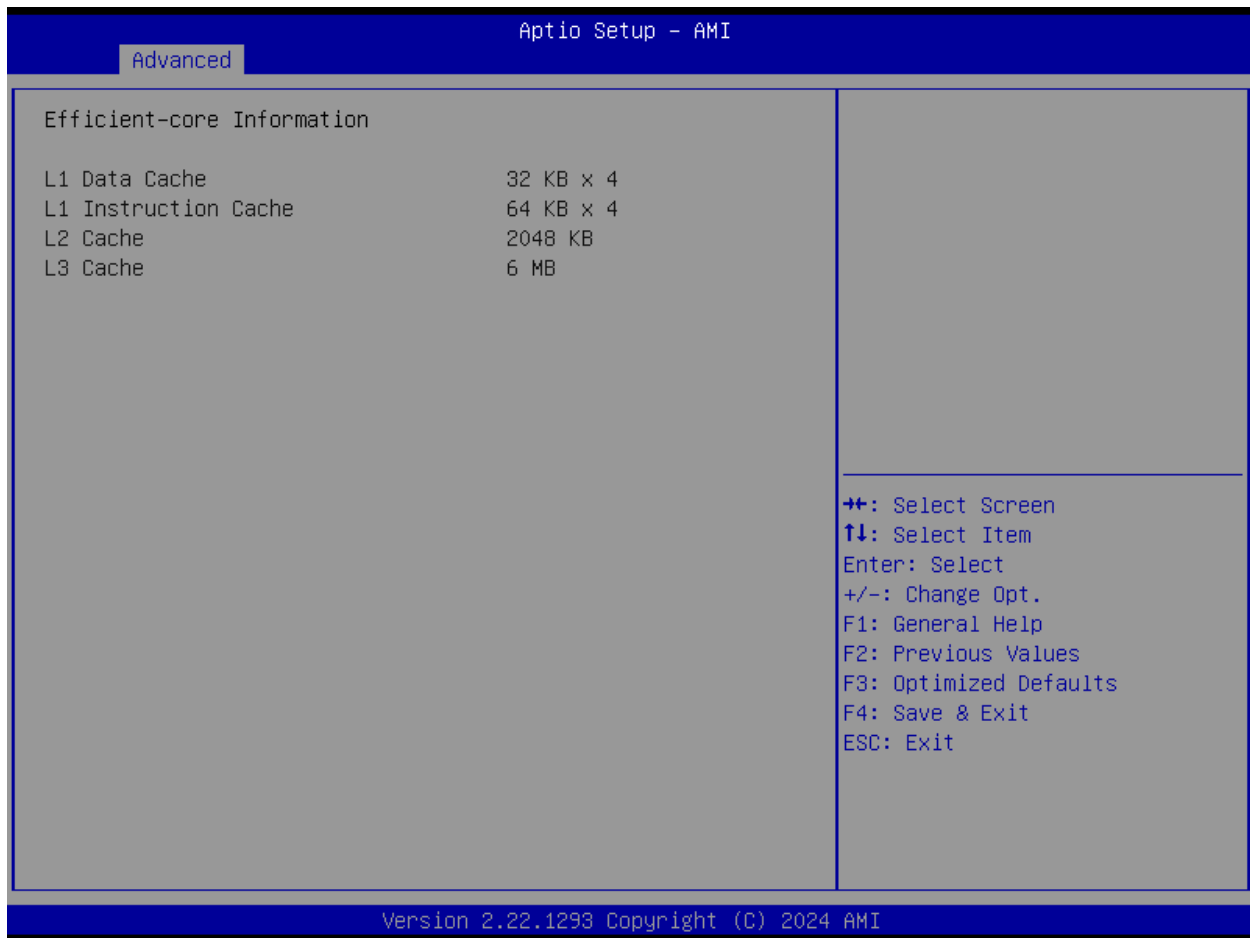

4.3.2 PCH-FW Configuration

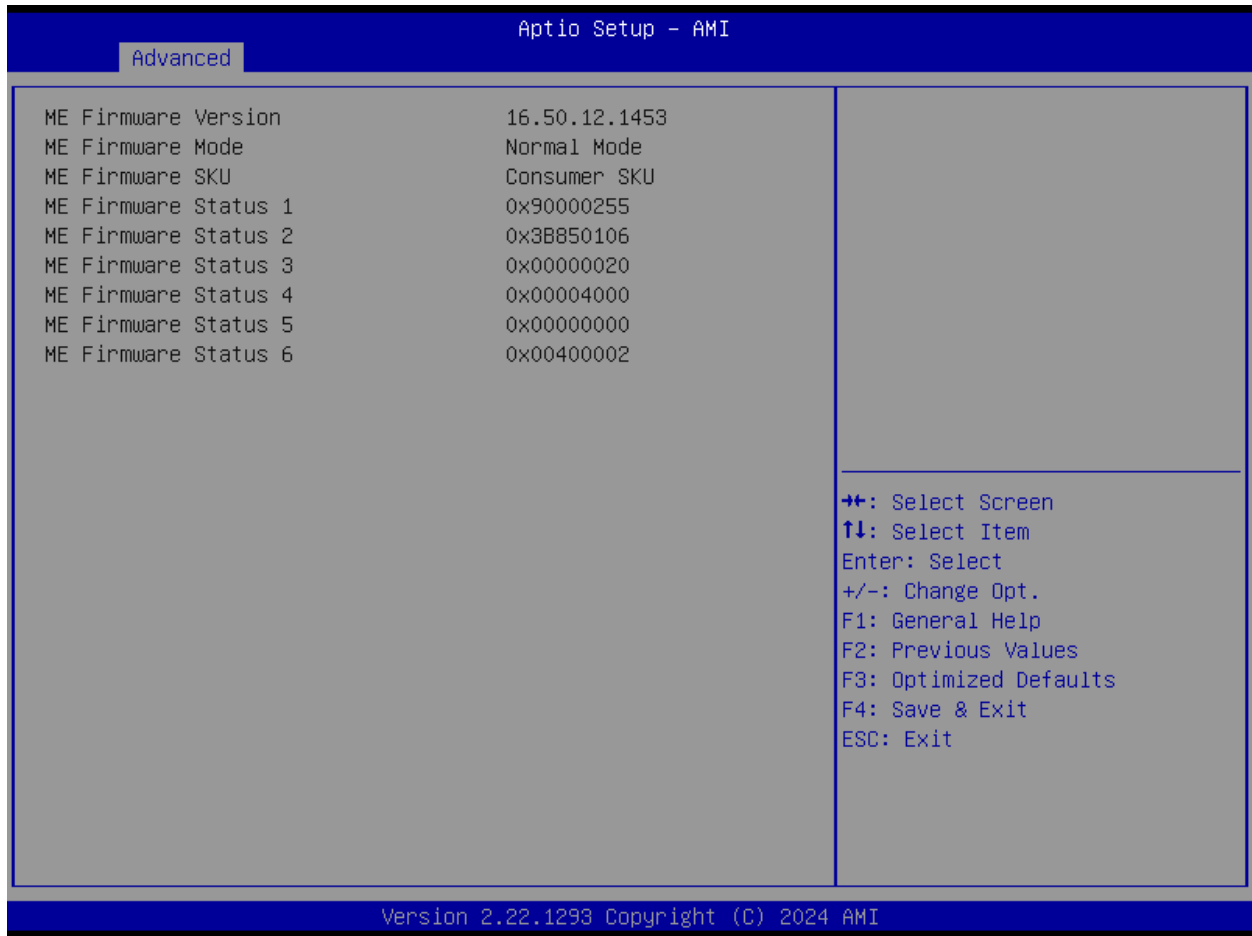

4.3.3 Trusted Computing



Item	Options	Description
Security Device Support	Enabled[Default], Disabled,	Enable/Disable BIOS support for security device. O.S. will not show Security Device. TCG EFI protocol and INT1A interface will not be available.
Pending operation	None[Default], TPM Clear	Schedule an Operation for the Security Device. NOTE: Your Computer will reboot during restart in order to change State of Security Device.

4.3.4 ACPI Settings

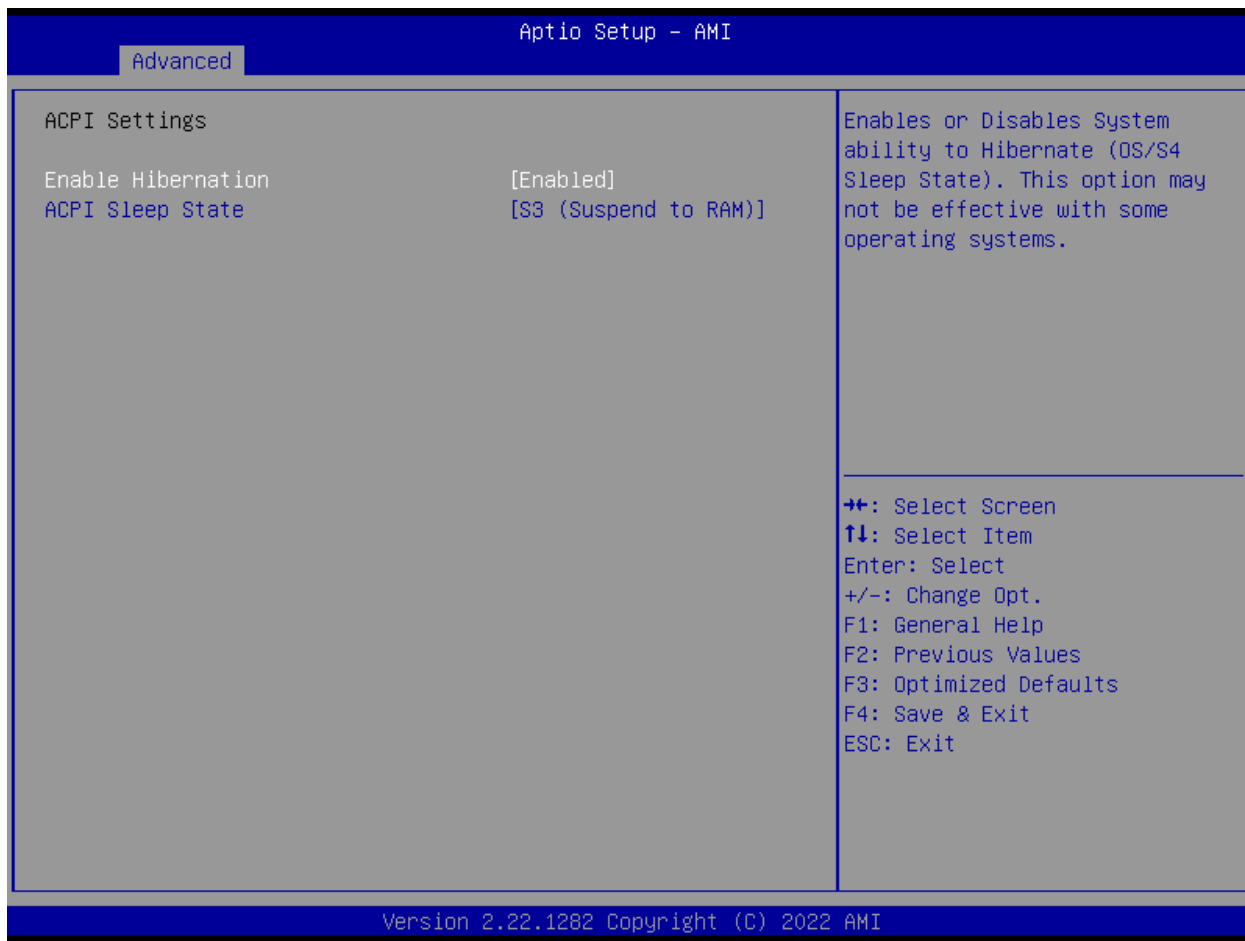

Item	Options	Description
Enable Hibernation	Disabled , Enabled[Default],	Enables or Disables System ability to Hibernate (OS/S4 Sleep State). This option may not be effective with some operating systems.
ACPI Sleep State	Suspend Disabled, S3 (Suspend to RAM)[Default]	Select the highest ACPI sleep state the system will enter when the SUSPEDN button is pressed.

4.3.5 Super IO Configuration

This setting allows you to select options for the Super IO Configuration, and change the value of the selected option.

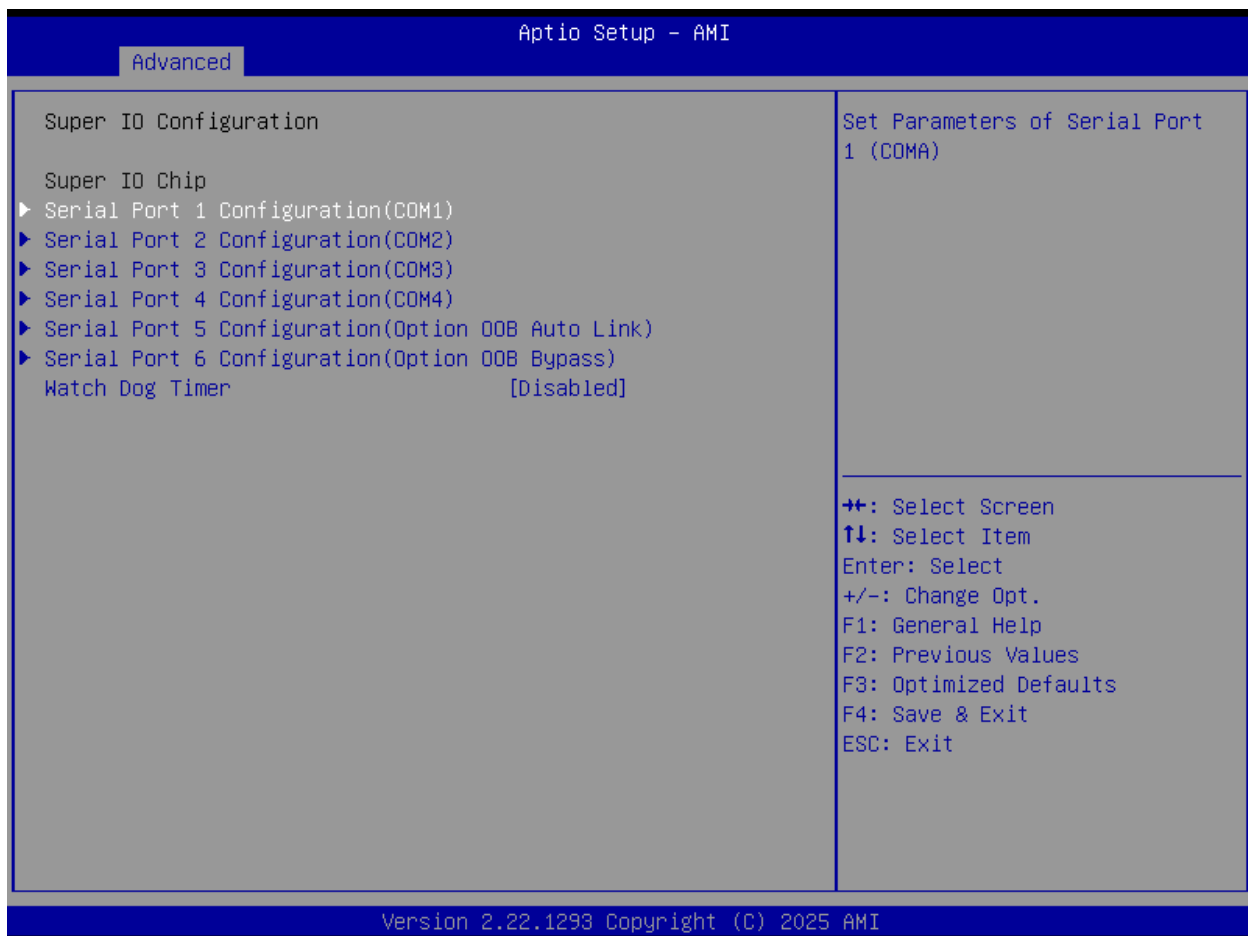

Item	Description
Serial Port 1 Configuration(COM1)	Set Parameters of Serial Port 1 (COMA).
Serial Port 2 Configuration(COM2)	Set Parameters of Serial Port 2 (COMB).
Serial Port 3 Configuration(COM3)	Set Parameters of Serial Port 3 (COMC).
Serial Port 4 Configuration(COM4)	Set Parameters of Serial Port 4 (COMD).
Serial Port 5 Configuration(Option OOB Auto Link)	Set Parameters of Serial Port 5 (COME)
Serial Port 6 Configuration(Option OOB Bypass)	Set Parameters of Serial Port 6 (COMF)

Item	Options	Description
Watch Dog Timer	Disabled [Default], Enabled	Enabled or Disabled Watch Dog Timer function.
Watch Dog Timer Count Mode	Second Mode[Default], Minute Mode	Select Second Mode or Minute Mode.
Watch Dog Timer Time out Value	20~255(Second)[Default], 1~255(Minute)	Watch Dog Timer Time out. Second 20-255 Minute 1-255

Serial Port 1 Configuration

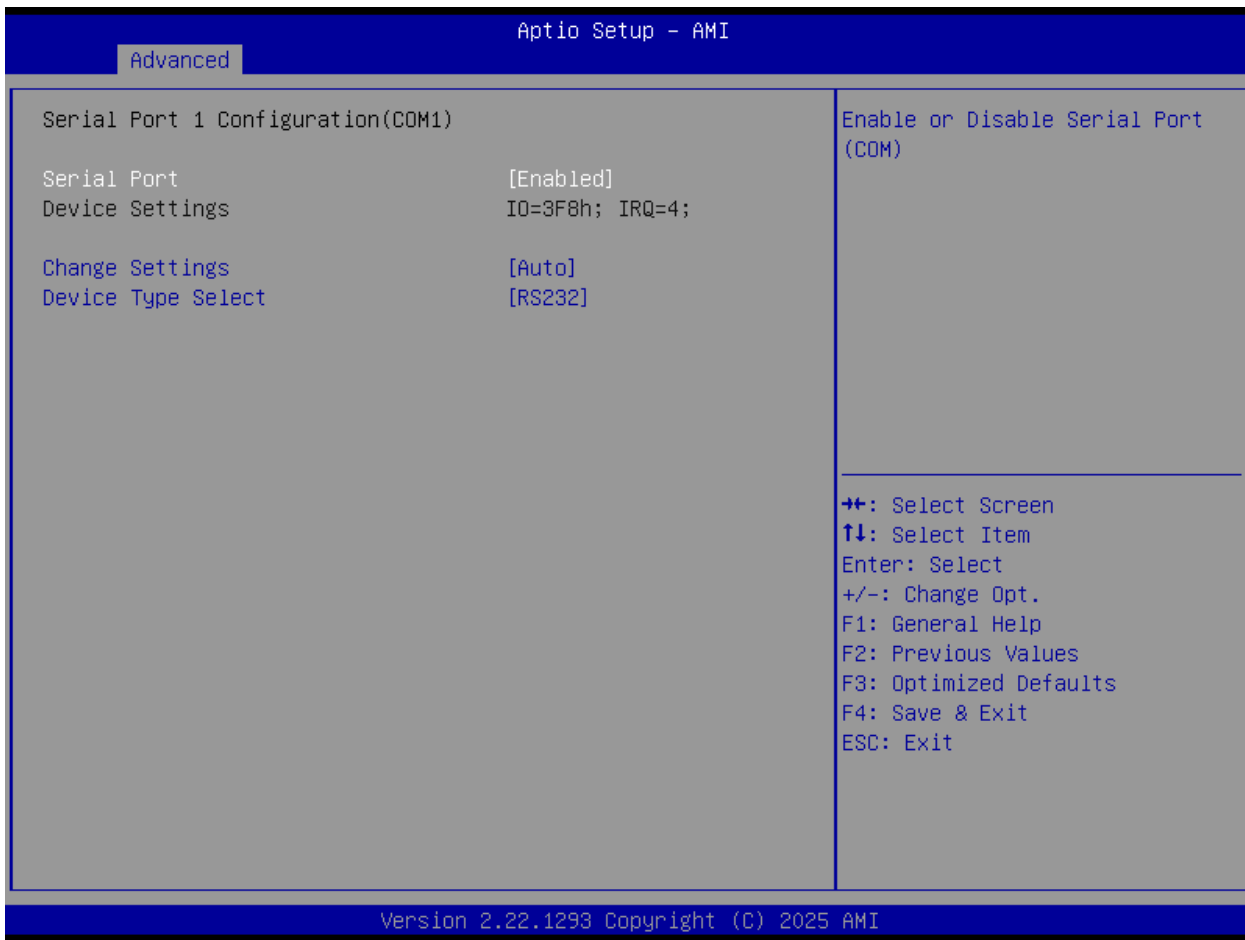

Item	Options	Description
Serial Port	Disabled, Enabled[Default]	Enable or Disable Serial Port (COM).
Change Settings	Auto[Default], IO=3F8h; IRQ=4; , IO=3F8h; IRQ=3,4,5,6,7,9,10,11,12;; IO=2F8h; IRQ=3,4,5,6,7,9,10,11,12;; IO=3E8h; IRQ=3,4,5,6,7,9,10,11,12;; IO=2E8h; IRQ=3,4,5,6,7,9,10,11,12;	Select an optimal settings for Super IO Device.
Device Type Select	RS232[Default], RS422, RS485	Set the Serial Port to RS232 & RS422 & RS485
RS-485 Auto Flow Function	Disabled, Enabled[Default]	Enabled/Disabled RS485 Autoflow Function

Serial Port 2 Configuration

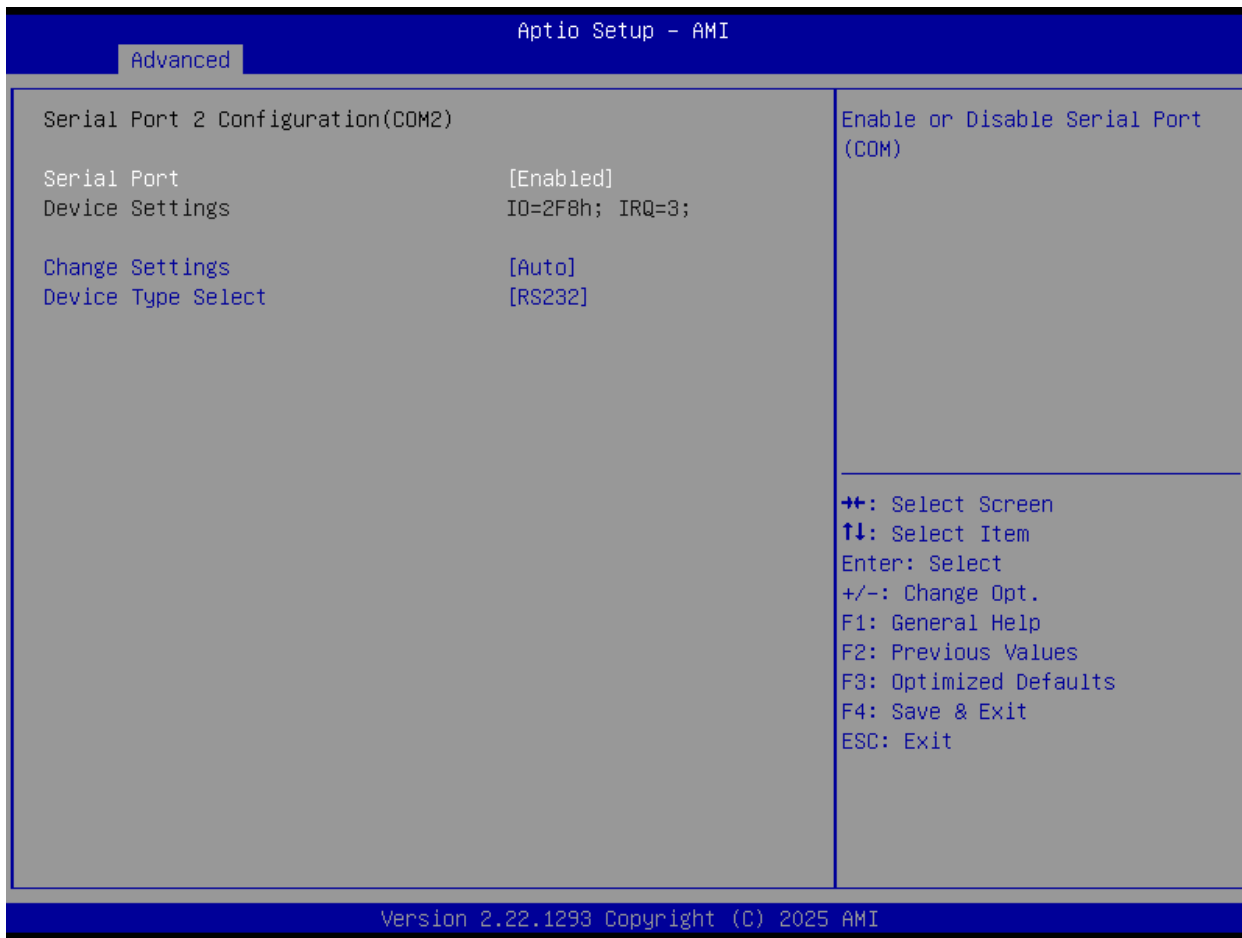

Item	Options	Description
Serial Port	Disabled, Enabled [Default]	Enable or Disable Serial Port (COM).
Change Settings	Auto [Default] , IO=2F8h; IRQ=3; , IO=3F8h; IRQ=3,4,5,6,7,9,10,11,12,, IO=2F8h; IRQ=3,4,5,6,7,9,10,11,12,, IO=3E8h; IRQ=3,4,5,6,7,9,10,11,12,, IO=2E8h; IRQ=3,4,5,6,7,9,10,11,12;	Select an optimal settings for Super IO Device.
Device Type Select	RS232 [Default] , RS422, RS485	Set the Serial Port to RS232 & RS422 & RS485
RS-485 Auto Flow Function	Disabled, Enabled [Default]	Enabled/Disabled RS485 Autoflow Function

Serial Port 3 Configuration

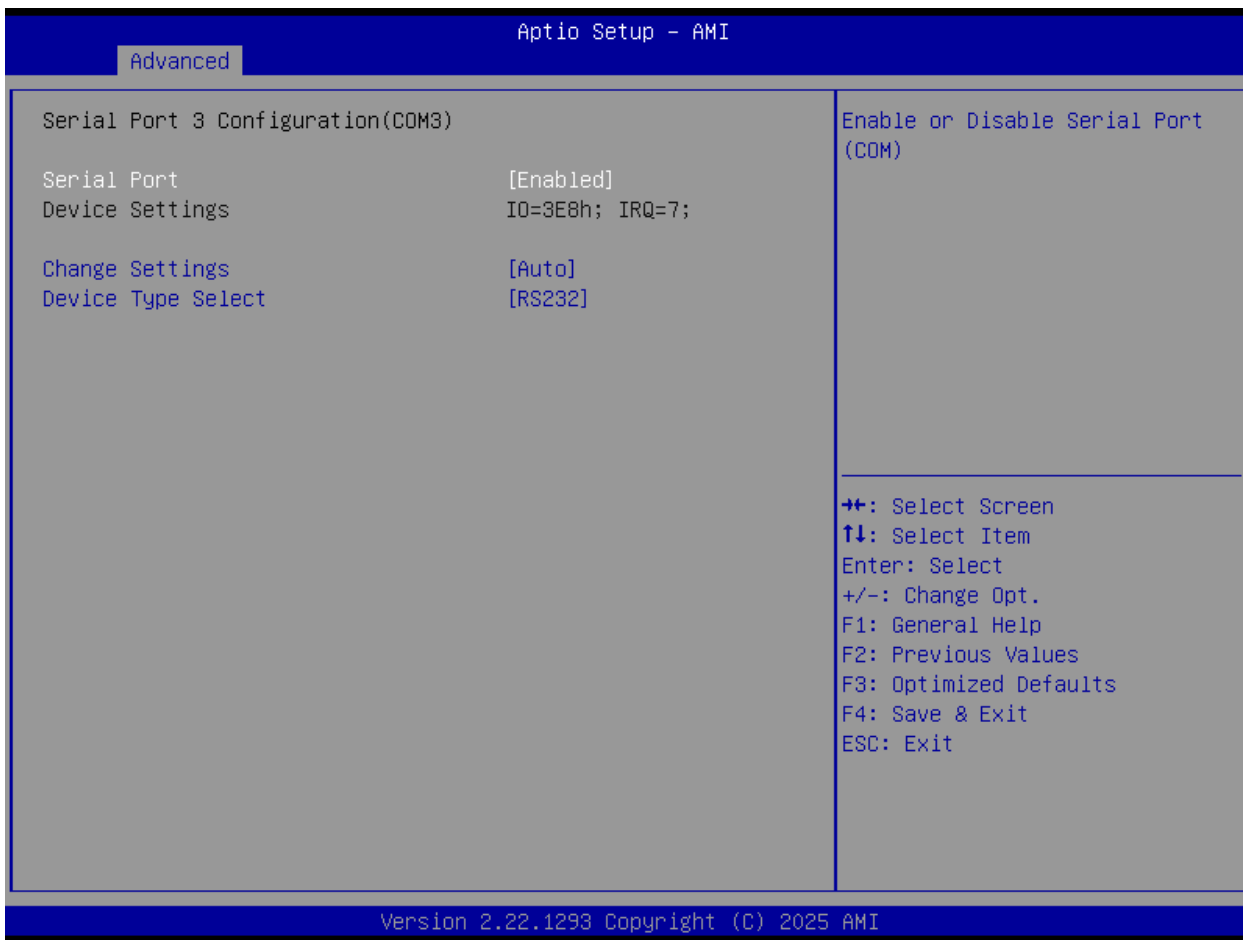

Item	Options	Description
Serial Port	Disabled, Enabled[Default]	Enable or Disable Serial Port (COM).
Change Settings	Auto[Default], IO=3E8h; IRQ=7; , IO=3E8h; IRQ=3,4,5,6,7,9,10,11,12;; IO=2E8h; IRQ=3,4,5,6,7,9,10,11,12;; IO=2F0h; IRQ=3,4,5,6,7,9,10,11,12;; IO=2E0h; IRQ=3,4,5,6,7,9,10,11,12;	Select an optimal settings for Super IO Device.
Device Type Select	RS232[Default], RS422, RS485	Set the Serial Port to RS232 & RS422 & RS485
RS-485 Auto Flow Function	Disabled, Enabled[Default]	Enabled/Disabled RS485 Autoflow Function

Serial Port 4 Configuration(For OOB Auto Link)

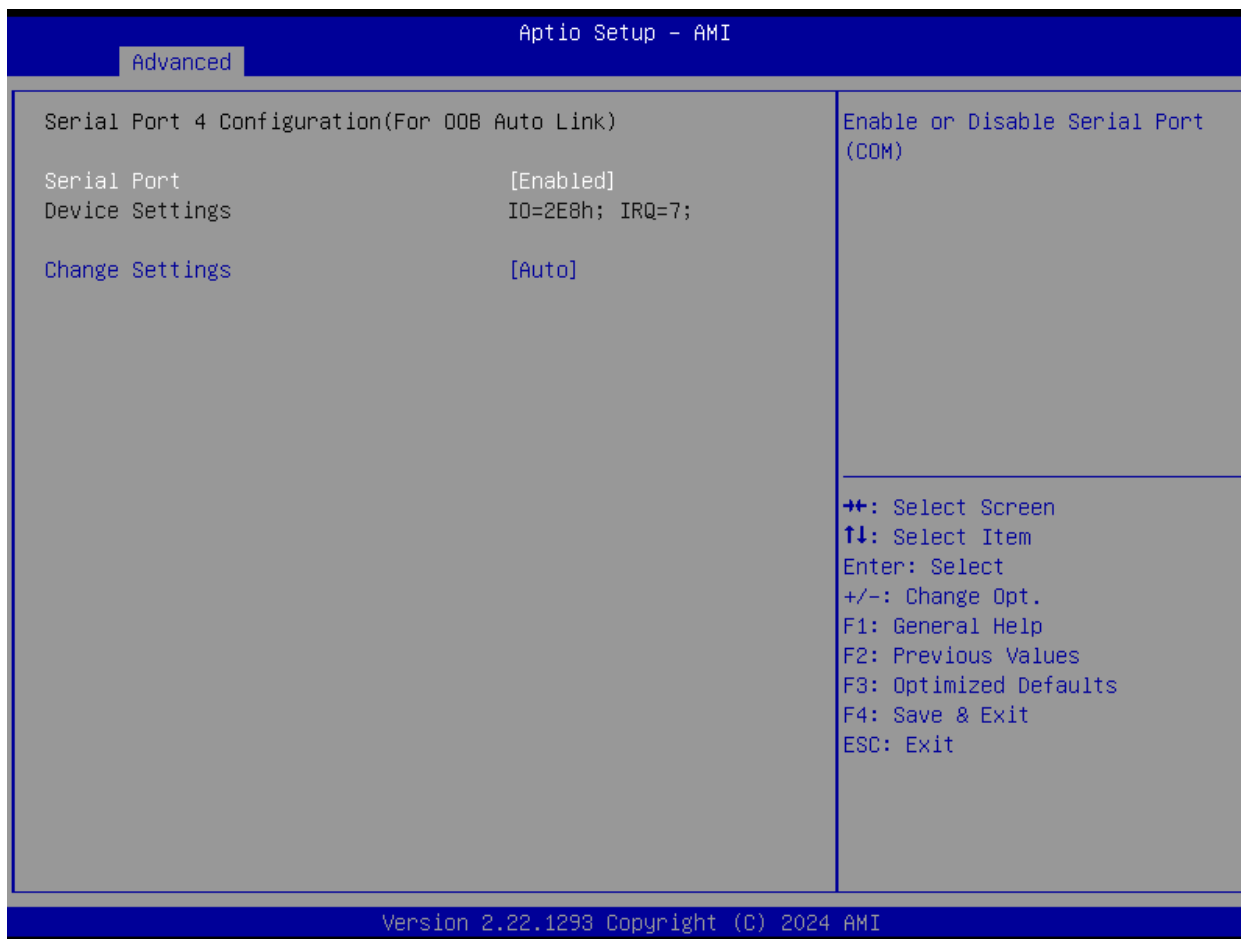

Item	Options	Description
Serial Port	Disabled, Enabled[Default]	Enable or Disable Serial Port (COM).
Change Settings	Auto[Default], IO=2E8h; IRQ=7; , IO=3E8h; IRQ=3,4,5,6,7,9,10,11,12; , IO=2E8h; IRQ=3,4,5,6,7,9,10,11,12;; IO=2F0h; IRQ=3,4,5,6,7,9,10,11,12;; IO=2E0h; IRQ=3,4,5,6,7,9,10,11,12;	Select an optimal settings for Super IO Device.
Device Type Select	RS232[Default], RS422, RS485	Set the Serial Port to RS232 & RS422 & RS485
RS-485 Auto Flow Function	Disabled, Enabled[Default]	Enabled/Disabled RS485 Autoflow Function

Serial Port 5 Configuration(Option OOB Auto Link)

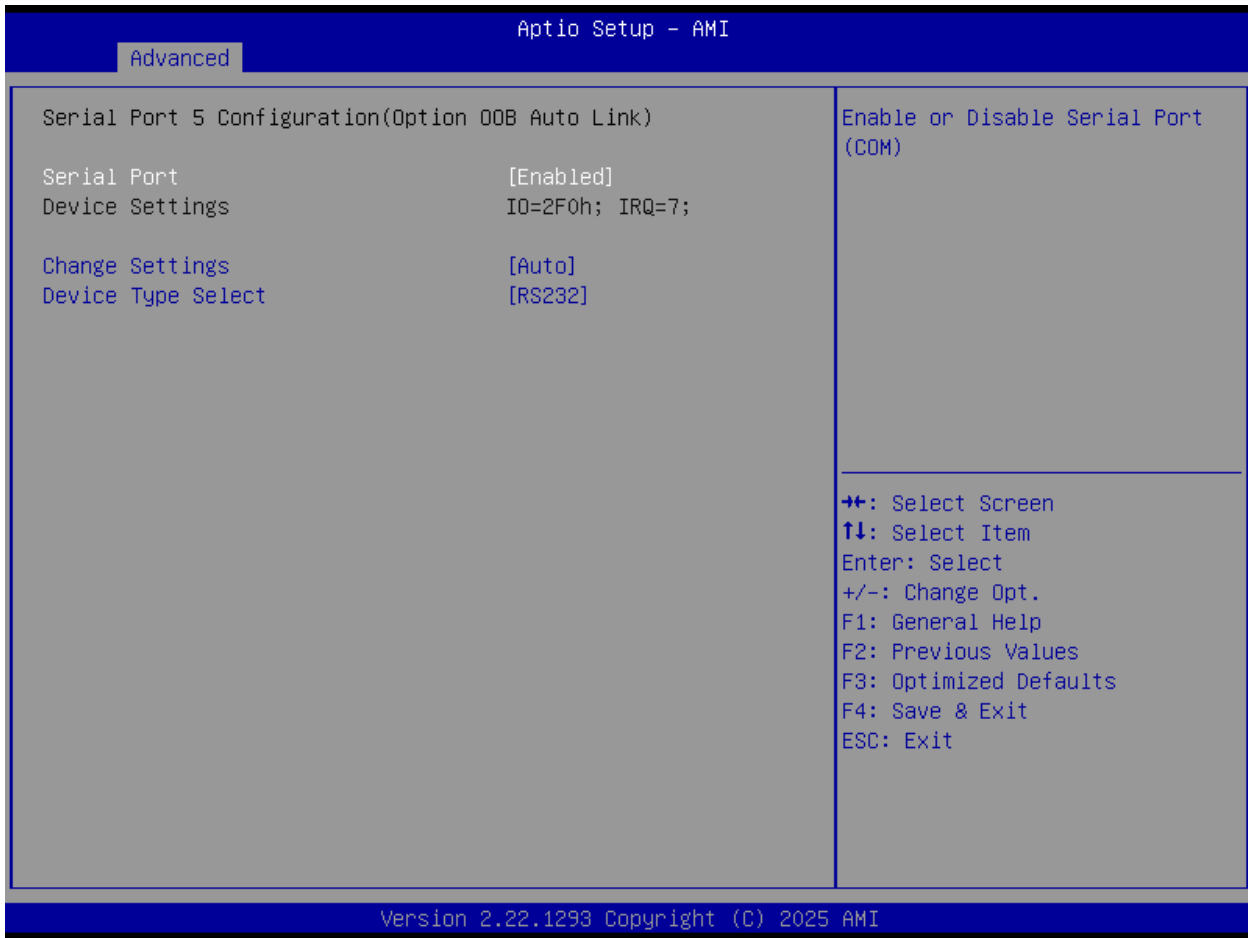

Item	Options	Description
Serial Port	Disabled, Enabled[Default]	Enable or Disable Serial Port (COM).
Change Settings	Auto[Default], IO=2Fh; IRQ=7; , IO=3E8h; IRQ=3,4,5,6,7,9,10,11,12; , IO=2E8h; IRQ=3,4,5,6,7,9,10,11,12; , IO=2F0h; IRQ=3,4,5,6,7,9,10,11,12; , IO=2E0h; IRQ=3,4,5,6,7,9,10,11,12;	Select an optimal settings for Super IO Device.
Device Type Select	RS232[Default], RS422, RS485	Set the Serial Port to RS232 & RS422 & RS485
RS-485 Auto Flow Function	Disabled, Enabled[Default]	Enabled/Disabled RS485 Autoflow Function

Serial Port 6 Configuration(Option OOB Bypass)

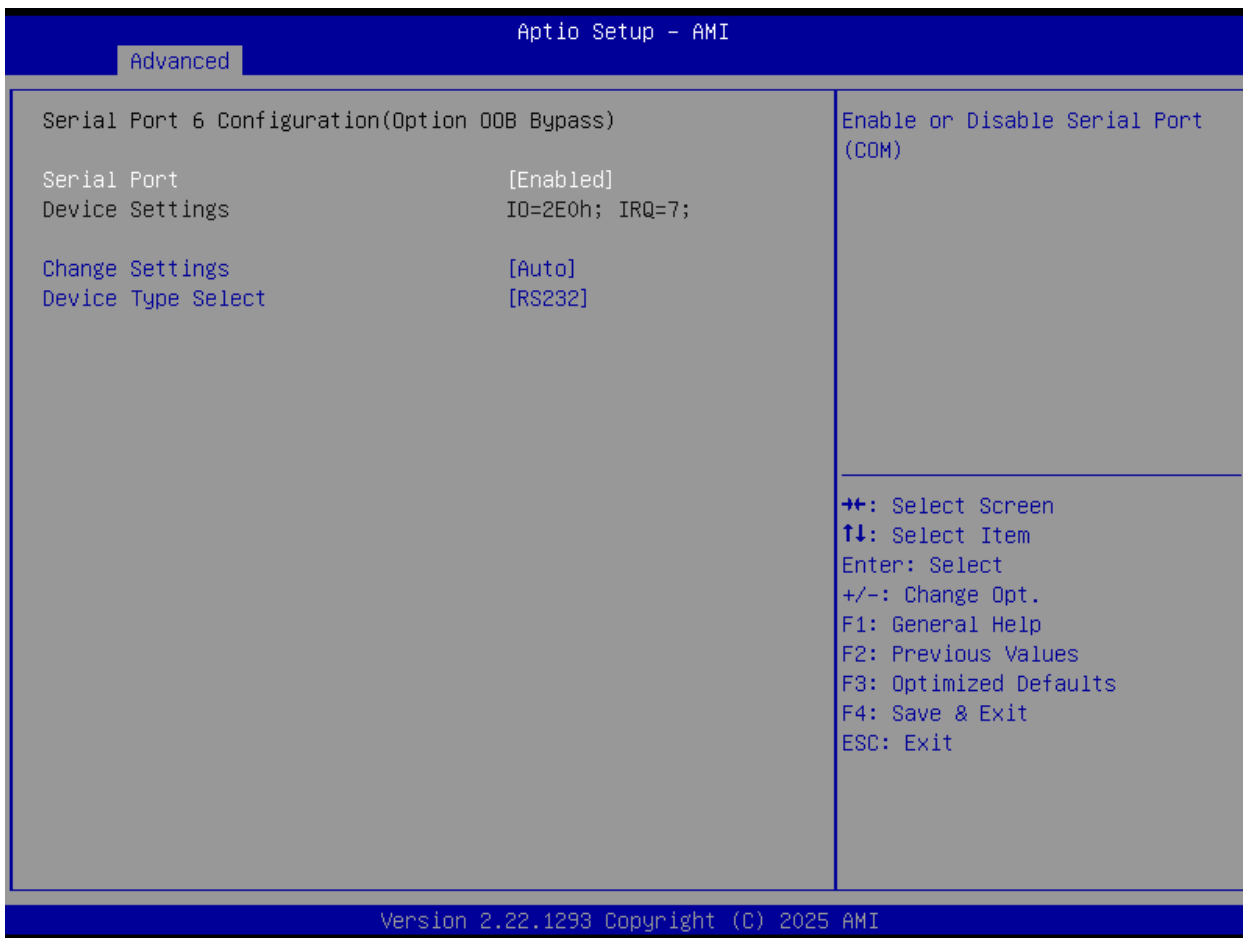

Item	Options	Description
Serial Port	Disabled, Enabled[Default]	Enable or Disable Serial Port (COM).
Change Settings	Auto[Default], IO=2Fh; IRQ=7; , IO=3E8h; IRQ=3,4,5,6,7,9,10,11,12; , IO=2E8h; IRQ=3,4,5,6,7,9,10,11,12; , IO=2F0h; IRQ=3,4,5,6,7,9,10,11,12; , IO=2E0h; IRQ=3,4,5,6,7,9,10,11,12;	Select an optimal settings for Super IO Device.
Device Type Select	RS232[Default], RS422, RS485	Set the Serial Port to RS232 & RS422 & RS485
RS-485 Auto Flow Function	Disabled, Enabled[Default]	Enabled/Disabled RS485 Autoflow Function

4.3.6 Hardware Monitor

These items display the current status of all monitored hardware devices/ components such as voltages and temperatures.

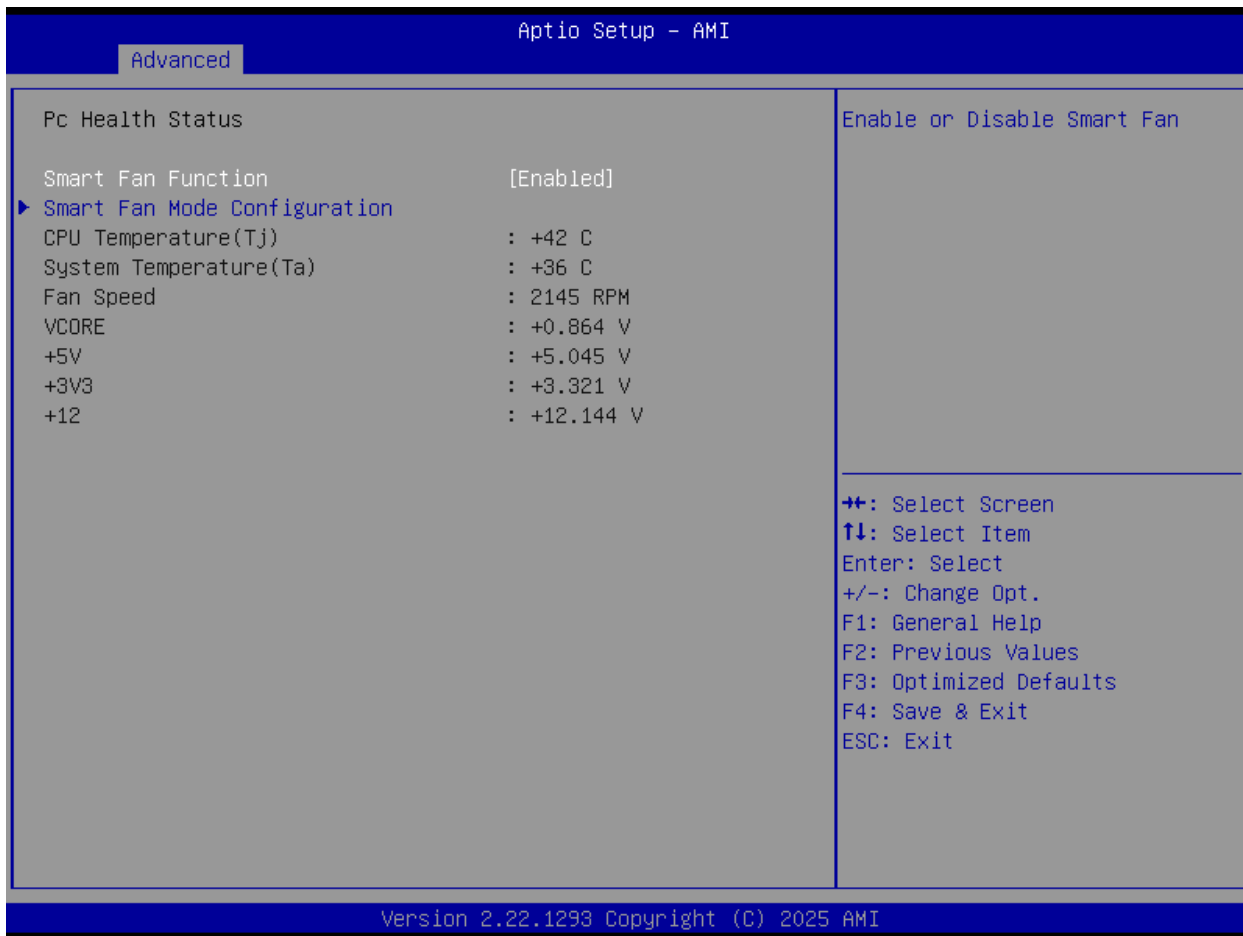

Item	Options	Description
Smart Fan Function	Disabled[Default], Enabled	Enabled or Disable Smart Fan

Smart Fan Mode Configuration

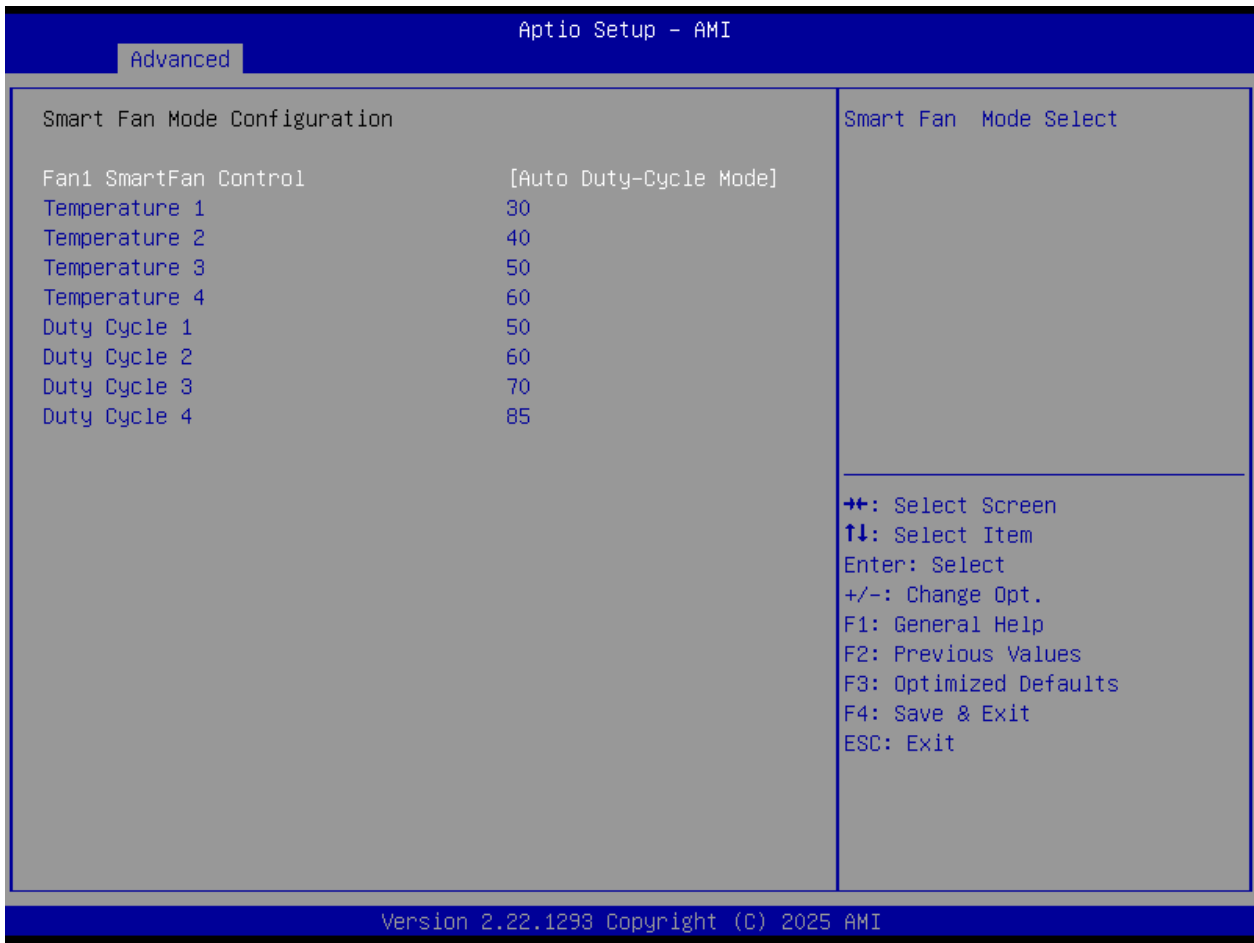

Item	Options	Description
FanSIO SmartFan Control	Manual Mode, Auto Duty-Cycle Mode[Default],	Smart Fan Mode Select
Temperature 1~4	1~100	Auto fan speed control. Temperature 1-100
Duty Cycle 1~4	20~100	Auto fan speed control. Duty 20-100

4.3.7. Power IGN Mode



Item	Options	Description
IGN Setting	Read mode[Default] Write IGN	Read IGN: BIOS will only read settings from IGN module. Write IGN: BIOS will overwrite settings in IGN module.
Power On Delay	10 Sec 20 Sec[Default] 30 Sec 40 Sec 50 Sec 1 Min Manual Mode	Power On Delay Select
Manual Mode	10 Sec[Default]	10~60 Sec
Power Off Delay	3 Sec[Default], 1 Min, 5 Min, 10 Min, 30 Min, 1 Hour, 2 Hour, Manual Mode	Power Off Delay Select
Manual Mode	3 Sec[Default]	3~7200 Sec

4.3.8 S5 RTC Wake Settings

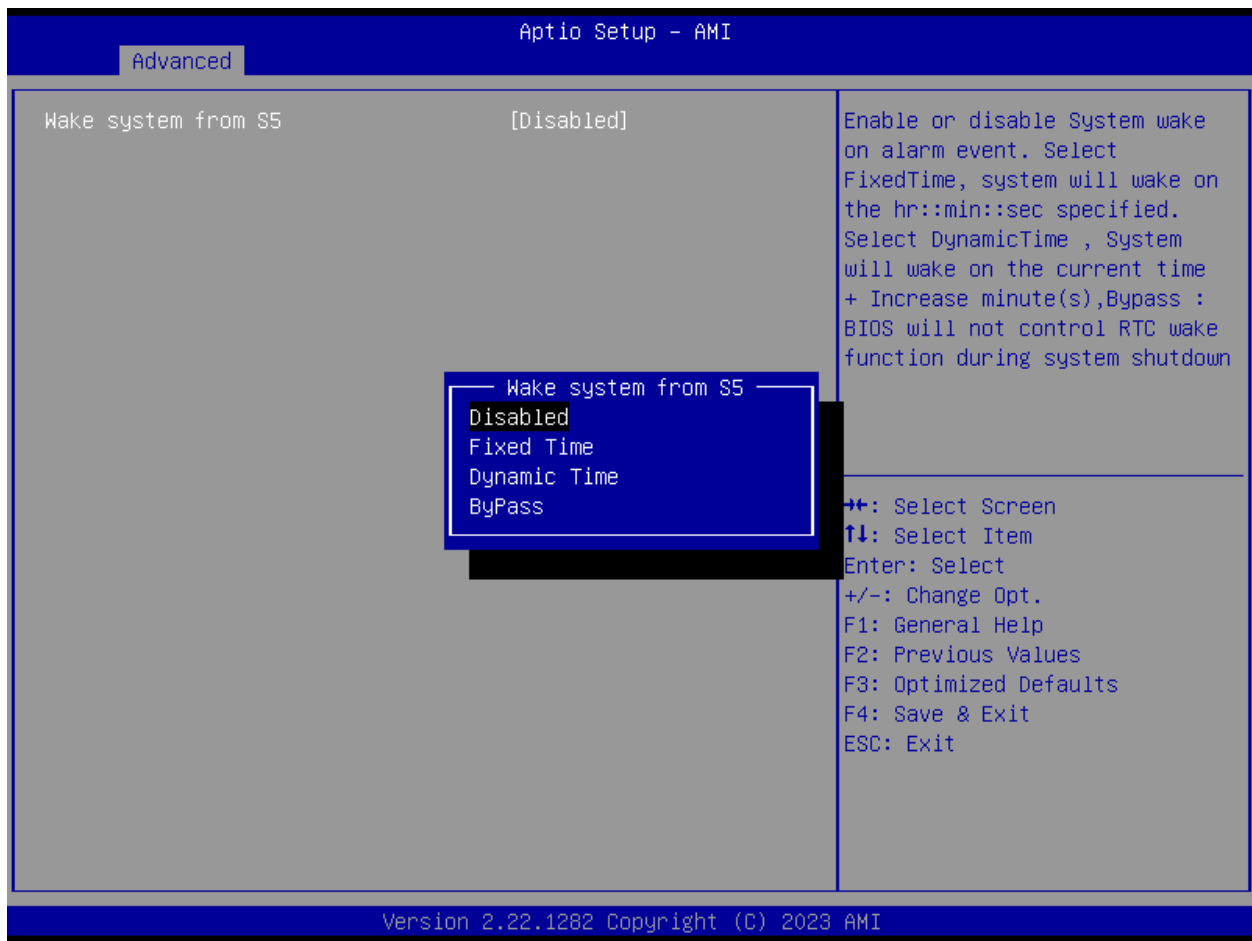

Item	Options	Description
Wake system from S5	Disabled[Default] Fixed Time Dynamic Time Bypass	Enable or disable System wake on alarm event. Select FixedTime, system will wake on the hr::min::sec specified. Select DynamicTime, System will wake on the current time + Increase minute(s), Select Bypass : BIOS will not control RTC wake function during system shutdown

4.3.9 Serial Port Console Redirection

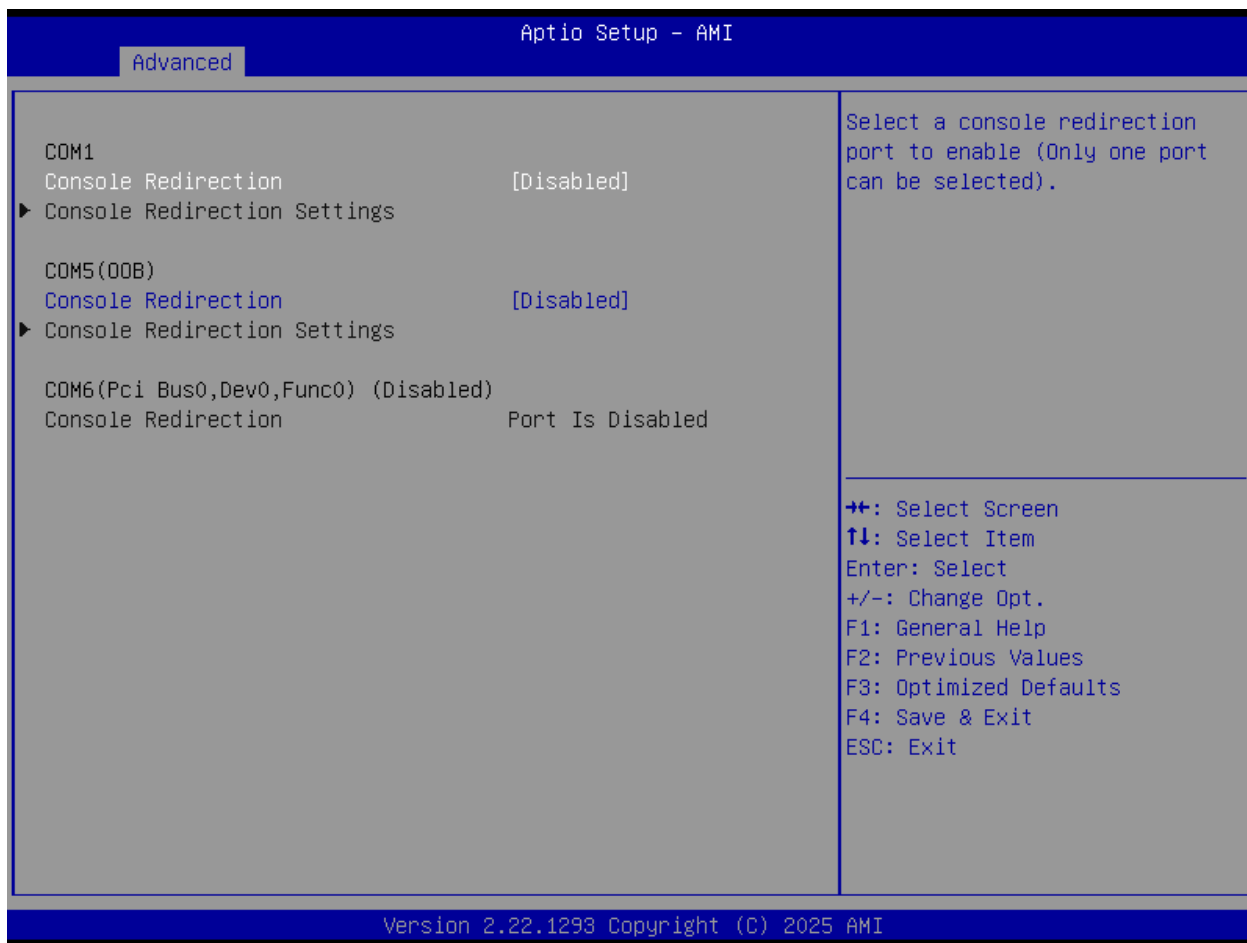

Item	Options	Description
Console Redirection	Disabled[Default], Enabled	Console Redirection Enable or Disable.

4.3.10 USB Configuration

Advanced		Aptio Setup - AMI	
USB Configuration		Enables Legacy USB support. AUTO option disables legacy support if no USB devices are connected. DISABLE option will keep USB devices available only for EFI applications.	
USB Module Version	32		
USB Controllers: 1 XHCI			
USB Devices: 1 Drive, 1 Keyboard			
Legacy USB Support	[Enabled]		
XHCI Hand-off	[Enabled]		
USB Mass Storage Driver Support	[Enabled]		
USB hardware delays and time-outs:		++: Select Screen ↑↓: Select Item Enter: Select +/-: Change Opt. F1: General Help F2: Previous Values F3: Optimized Defaults F4: Save & Exit ESC: Exit	
USB transfer time-out	[20 sec]		
Device reset time-out	[20 sec]		
Device power-up delay	[Auto]		
Mass Storage Devices:			
JetFlashTranscend 64GB 1100	[Auto]		

Version 2.22.1293 Copyright (C) 2024 AMI

Item	Options	Description
Legacy USB Support	Enabled[Default], Disabled Auto	Enables Legacy USB support. AUTO option disables legacy support if no USB devices are connected. DISABLE option will keep USB devices available only for EFI applications.
XHCI Hand-off	Enabled[Default], Disabled	This is a workaround for OS without XHCI hand-off support. The XHCI ownership change should be claimed by XHCI driver.
USB Mass Storage Driver Support	Disabled, Enabled[Default]	Enable/Disable USB Mass Storage Driver Support.
USB transfer time-out	1 sec, 5 sec, 10 sec, 20 sec[Default]	The time-out value for Control, Bulk, and Interrupt transfers.
Device reset time-out	10 sec , 20 sec[Default], 30 sec, 40 sec	USB mass storage device Start Unit command time-out.
Device power-up delay	Auto[Default], Manual	Maximum time the device will take before it properly reports itself to the Host Controller. 'Auto' uses default value: for a Root port it is 100ms, for a Hub port the delay is taken from Hub descriptor.

4.3.11 Network Stack Configuration



Item	Options	Description
Network Stack	Disabled[Default] , Enabled	Enable/Disable UEFI Network Stack.
IPv4 PXE Support	Disabled[Default] , Enabled	Enable/Disable IPv4 PXE boot support. If disabled, IPv4 PXE boot support will not be available.
IPv4 HTTP Support	Disabled[Default] , Enabled	Enable/Disable IPv4 HTTP boot support. If disabled, IPv4 HTTP boot support will not be available.
IPv6 PXE Support	Disabled[Default] , Enabled	Enable/Disable IPv6 PXE boot support. If disabled, IPv6 PXE boot support will not be available.
IPv6 HTTP Support	Disabled[Default] , Enabled	Enable/Disable IPv6 HTTP boot support. If disabled, IPv6 HTTP boot support will not be available.
PXE boot wait time	0	Wait time in seconds to press ESC key to abort the PXE boot. Use either +/- or numeric keys to set the value.
Media detect count	1	Number of times the presence of media will be checked. Use either +/- or numeric keys to set the value.

4.3.12 NVMe Configuration



4.4 Chipset

This section allows you to configure and improve your system and allows you to set up some system features according to your preference.



4.4.1 System Agent (SA) Configuration

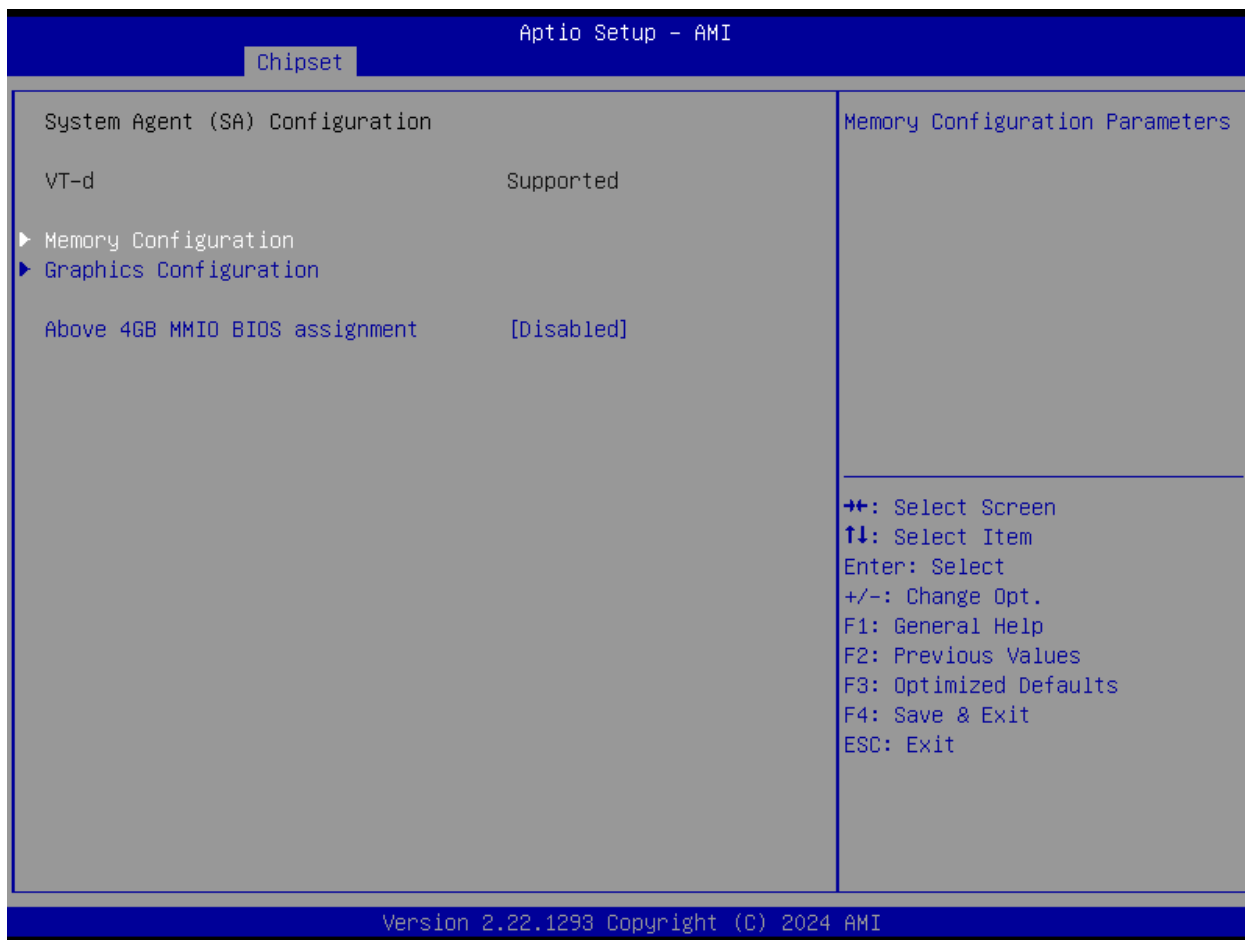

Item	Description
Memory Configuration	Memory Configuration Parameters
Graphics Configuration	Graphics Configuration

Item	Options	Description
Above 4GB MMIO BIOS assignment	Enabled, Disabled[Default]	Enable/Disable above 4GB MemoryMappedIO BIOS assignment\n\nThis is enabled automatically when Aperture Size is set to 2048MB.

Memory Configuration

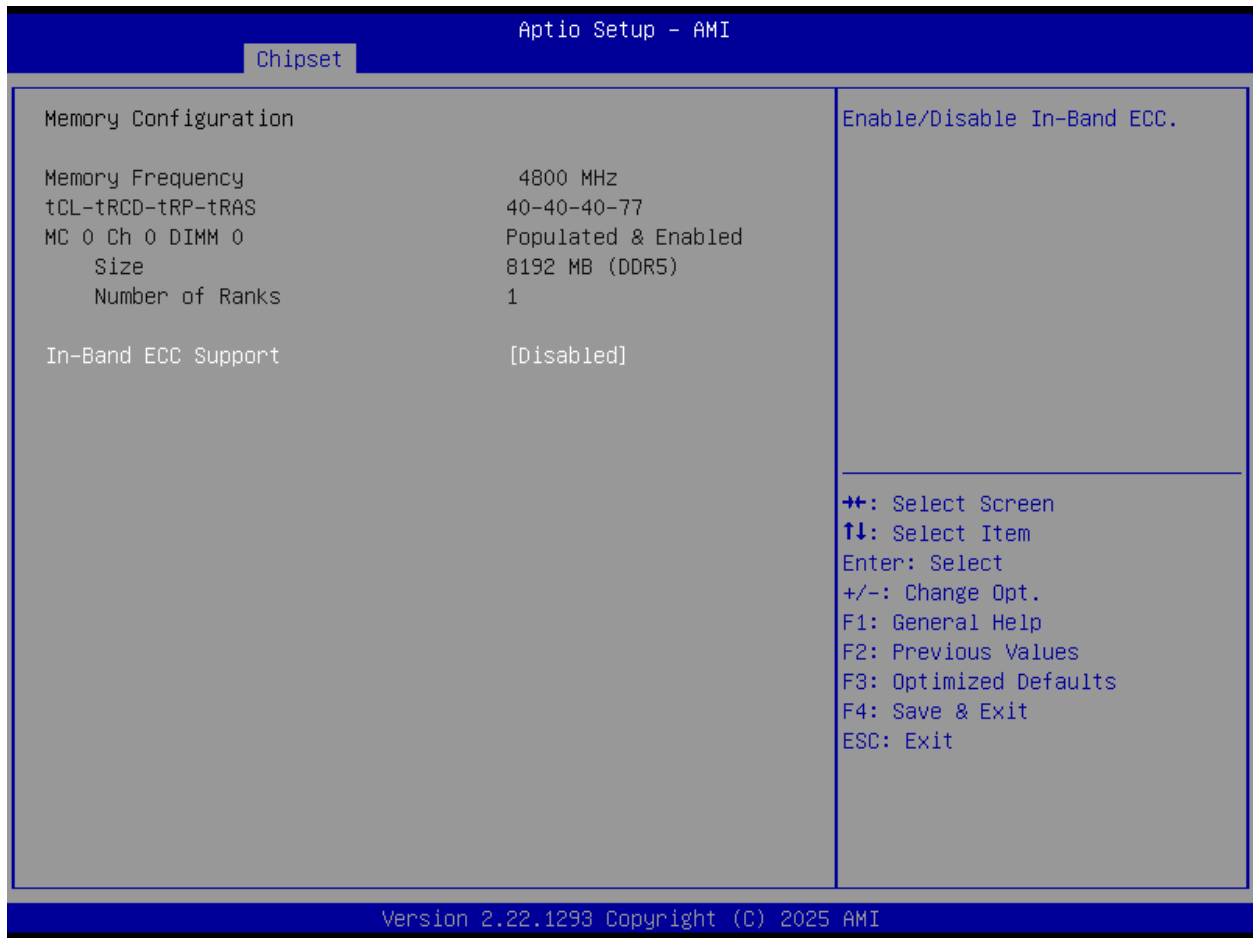

Item	Options	Description
In-Band ECC Support	Disabled[Default], Enabled	Enable/Disable In-Band ECC.

Graphic Configuration

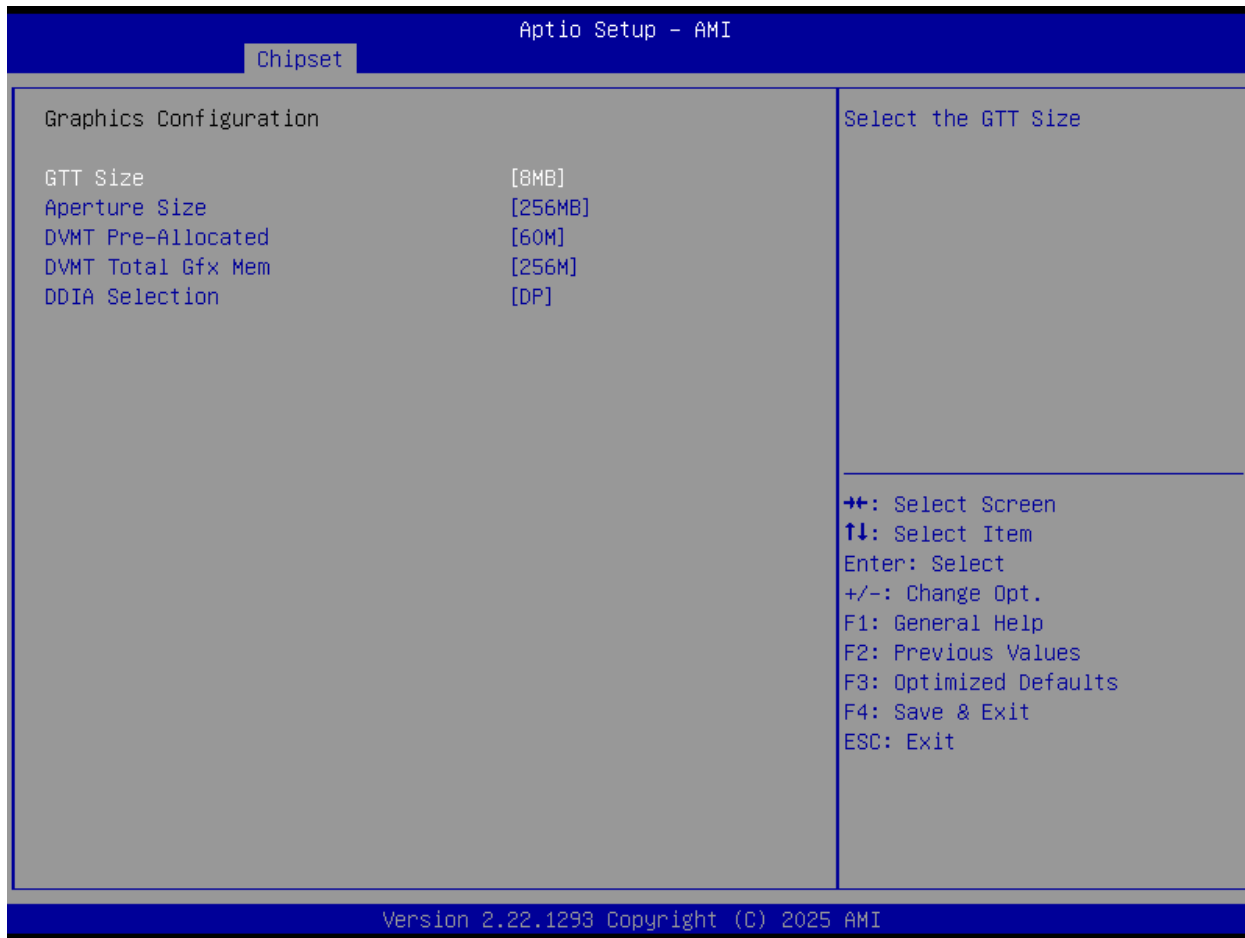

Item	Options	Description
GTT Size	2MB, 4MB, 8MB[Default]	Select the GTT Size .
Aperture Size	128MB, 256MB[Default] , 512MB, 1024MB	Select the Aperture Size. Note : Above 4GB MMIO BIOS assignment is automatically enabled when selecting > 2048MB aperture. To use this feature, please disable CSM Support.
DVMT Pre-Allocated	32M,64M,96M,128M, 160M, 36M, 40M,44M, 48M,52M,56M, 60M[Default]	Select DVMT 5.0 Pre-Allocated (Fixed) Graphics Memory size used by the Internal Graphics Device.
DVMT Total Gfx Mem	128M, 256M[Default] , MAX	Select DVMT5.0 Total Graphic Memory size used by the Internal Graphics Device.
DDIA Selection	DP[Default] , HDMI	Selects DDIA function: DP or HDMI

4.4.2 PCH-IO Configuration

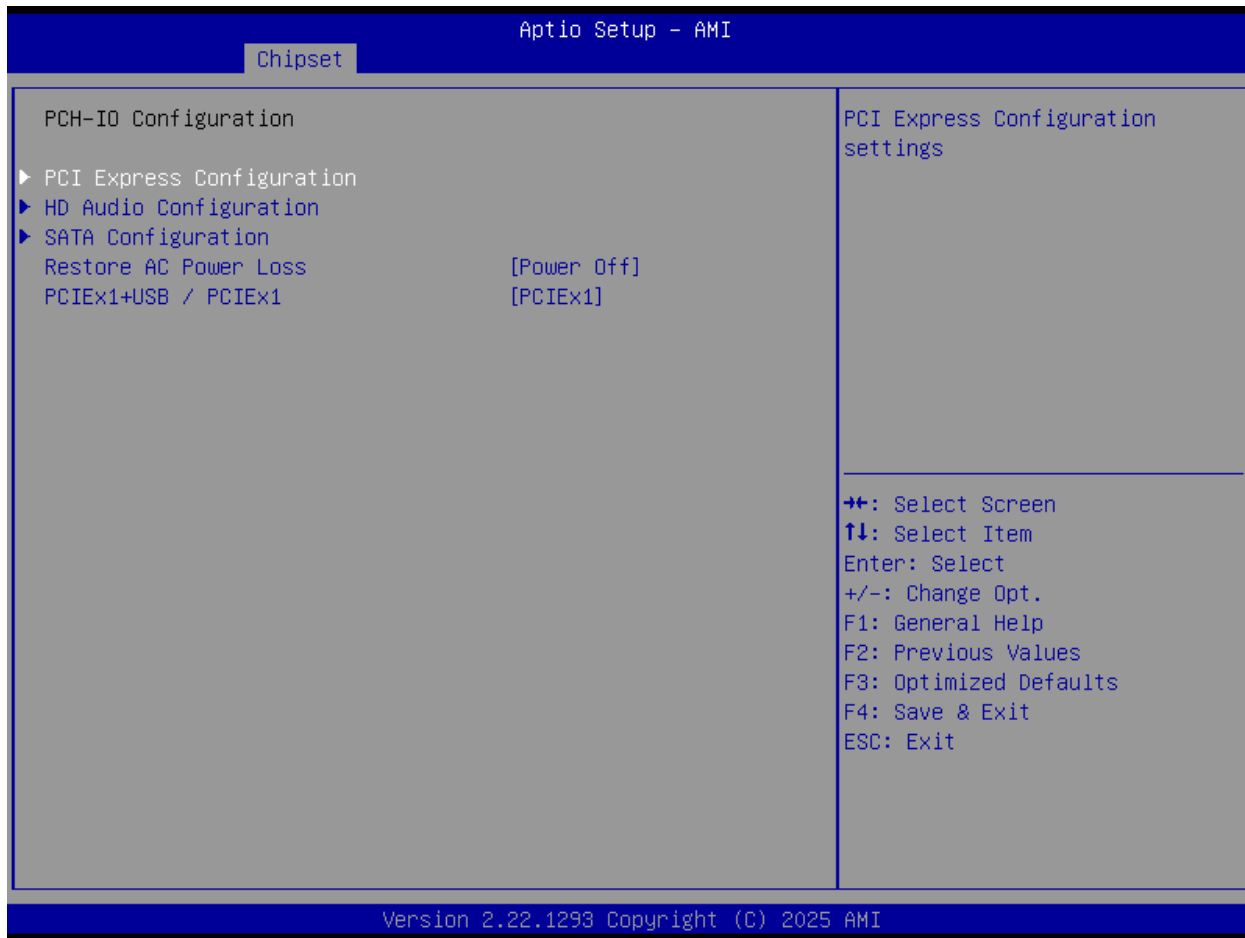

Item	Description
PCI Express Configuration	PCI Express Configuration settings.

Item	Options	Description
Restore AC Power Loss	Power On, Power Off [Default], Last State	Specify what state to go to when power is re-applied after a power failure (G3 state).
PCIEx1+USB / PCIEx1	PCIEx1+USB, PCIEx1[Default]	If the device is PCIEx2, please select PCIEx1, otherwise select PCIEx1+USB

■ PCI Express Configuration

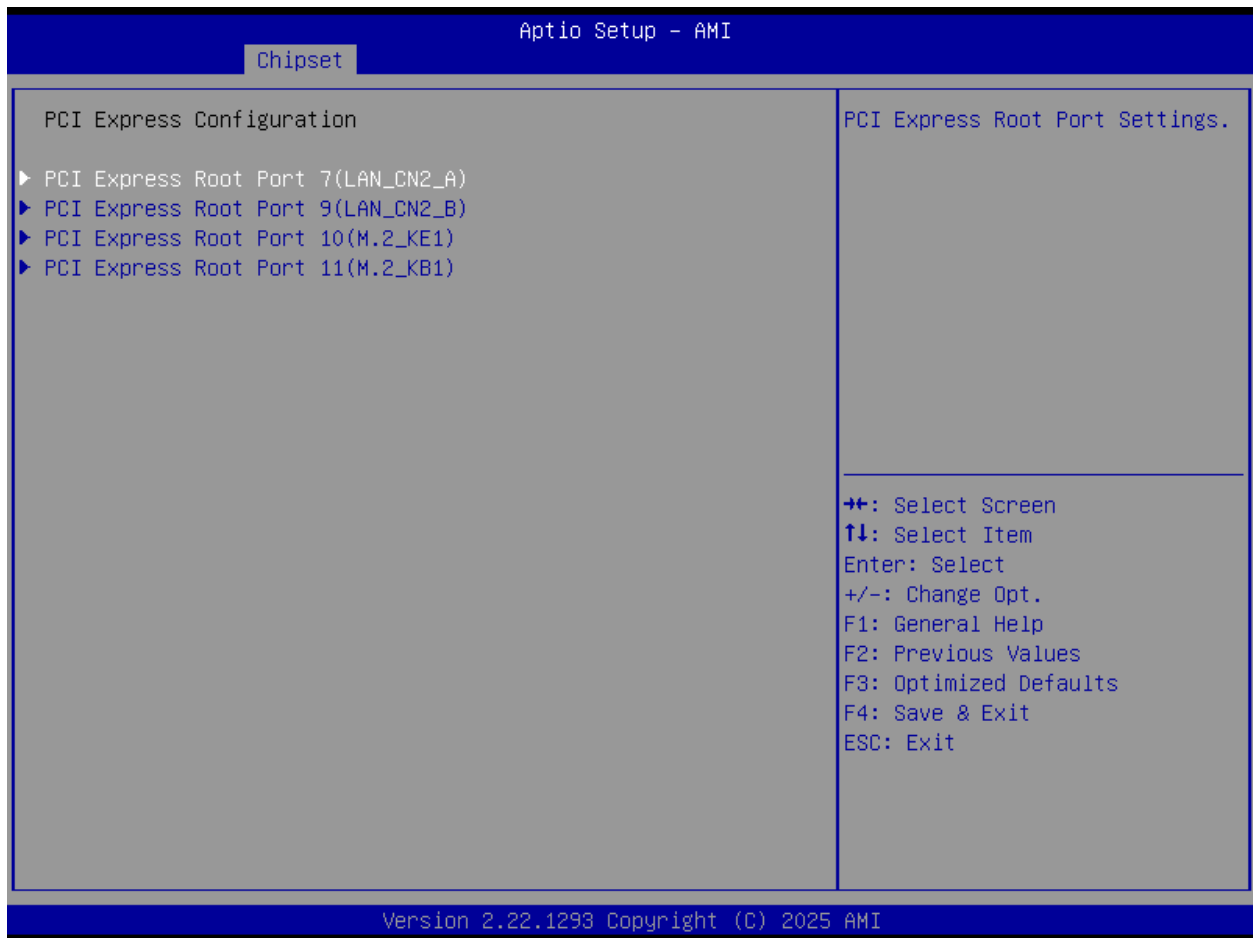

- **PCI Express Root Port 4//9/10/11**

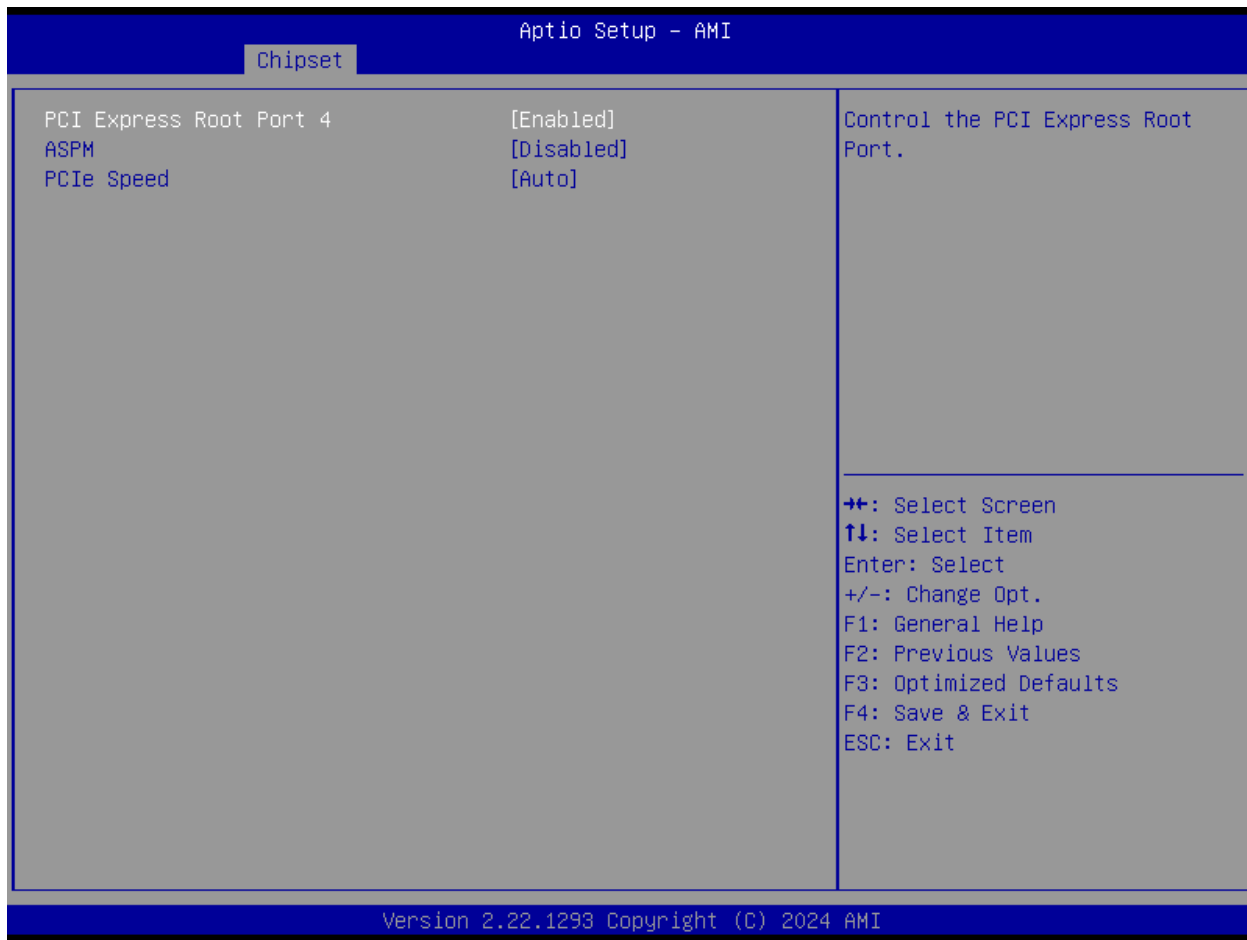

Item	Options	Description
PCI Express Root Port 4//7/9/11/12	Disabled, Enabled [Default]	Control the PCI Express Root Port.
ASPM	Disabled [Default] , L1, Auto	Set the ASPM Level: Force L0s - Force all links to L0s State, AUTO - BIOS auto configure, DISABLE - Disables ASPM,
PCIe Speed	Auto [Default] , Gen1, Gen2, Gen3	Configure PCIe speed.

■ HD Audio Configuration

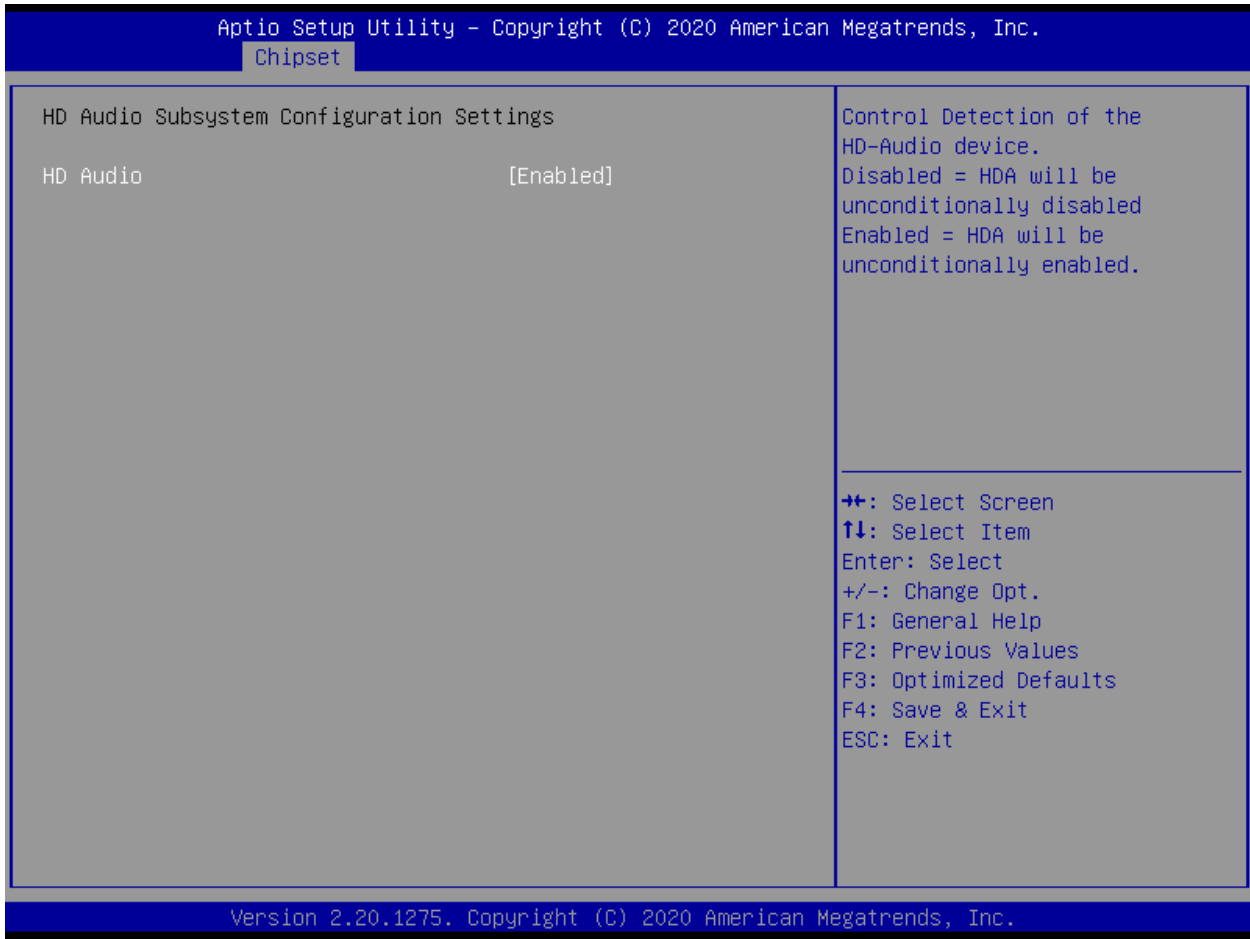

Item	Options	Description
HD Audio	Disabled, Enabled [Default]	Control Detection of the HD-Audio device. Disabled = HDA will be unconditionally disabled Enabled = HDA will be unconditionally enabled.

SATA Configuration

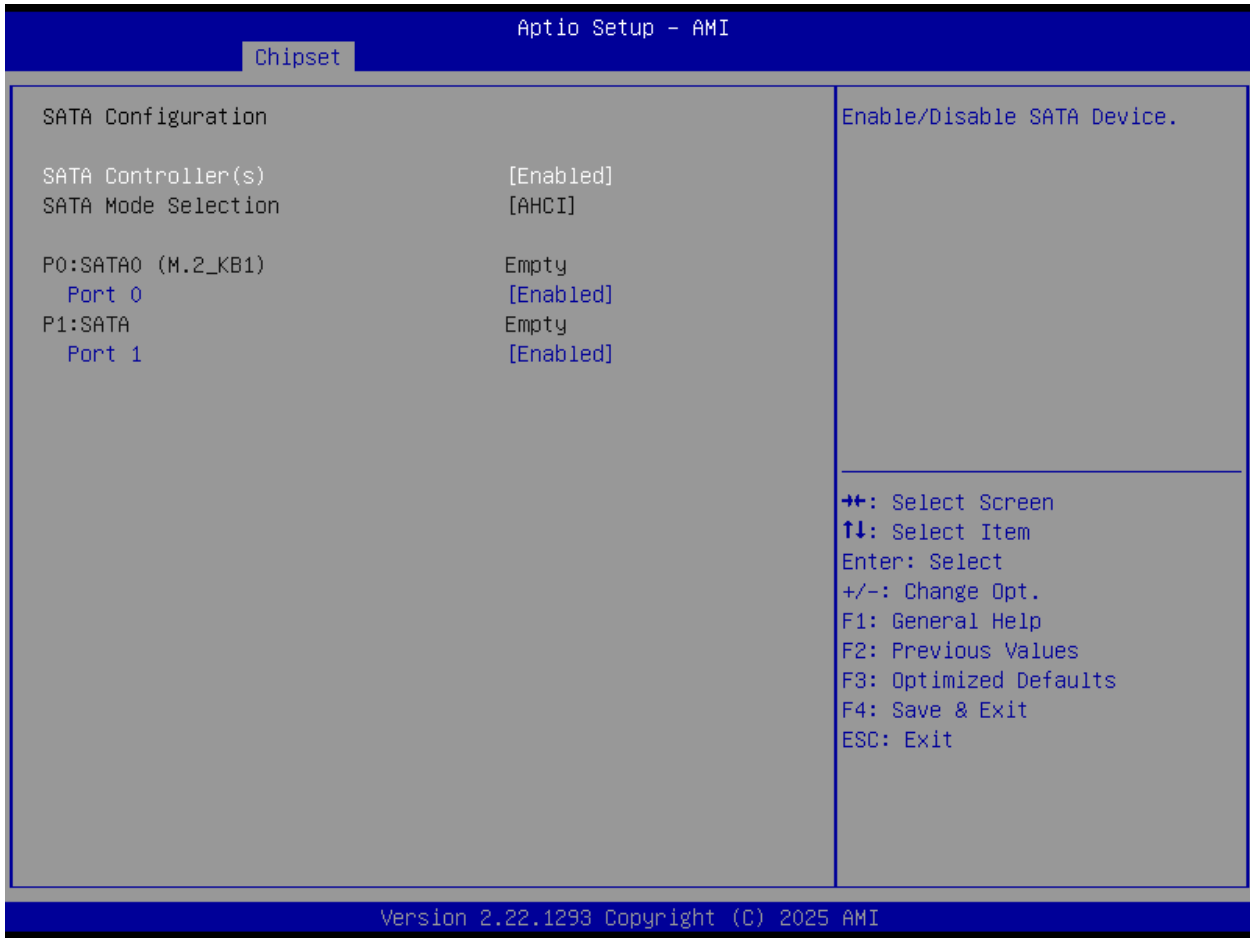

Item	Options	Description
SATA Controller(s)	Enabled[Default] Disabled	Enable/Disable SATA Device.
SATA Port	Disabled, Enabled[Default]	Enable/Disable SATA Port.

4.5 Security

Security menu allow users to change administrator password and user password settings.

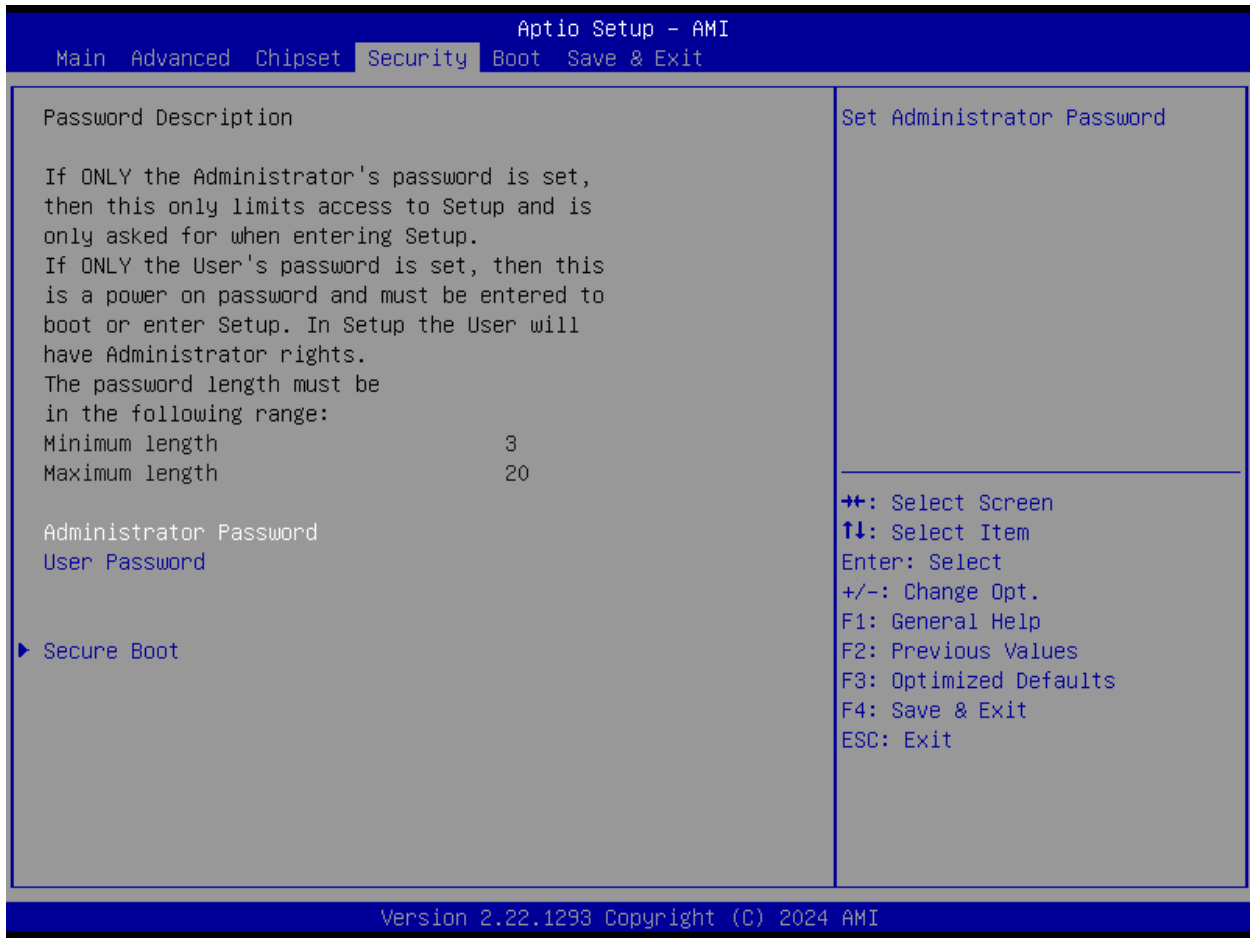

■ Administrator Password

This item allows you to set Administrator Password.

■ User Password

This item allows you to set User Password.

■ Security Boot

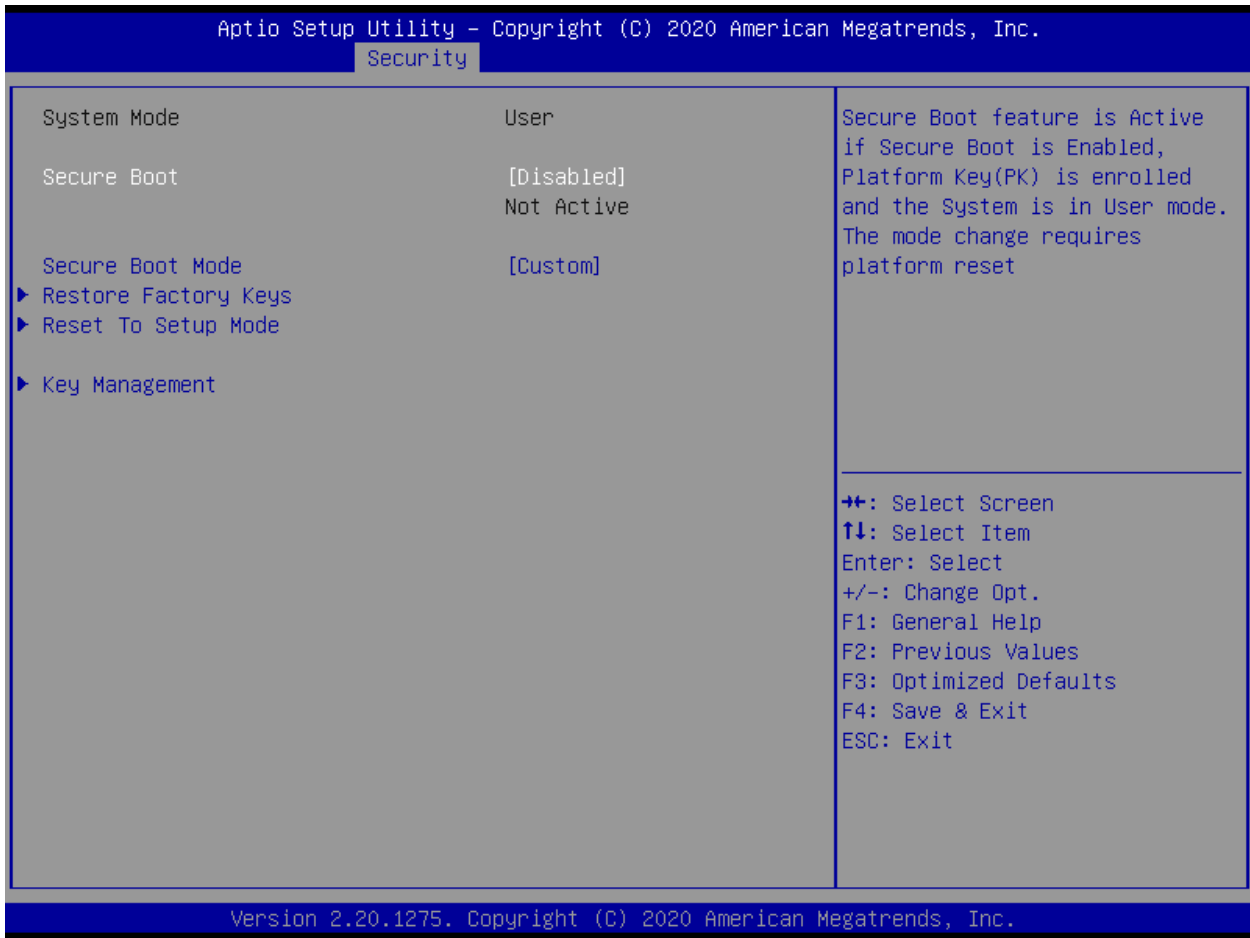

Item	Options	Description
Secure Boot	Disabled [Default] , Enabled	Secure Boot feature is Active if Secure Boot is Enabled, Platform Key(PK) is enrolled and the System is in User mode. The mode change requires platform reset
Secure Boot Mode	Standard, Custom [Default]	Secure Boot mode options: Standard or Custom. In Custom mode, Secure Boot Policy variables can be configured by a physically present user without full authentication

Item	Description
Restore Factory Keys	Force system to User Mode. Install factory default Secure Boot key databases
Key Management	Enables expert users to modify Secure Boot Policy variables without variable authentication

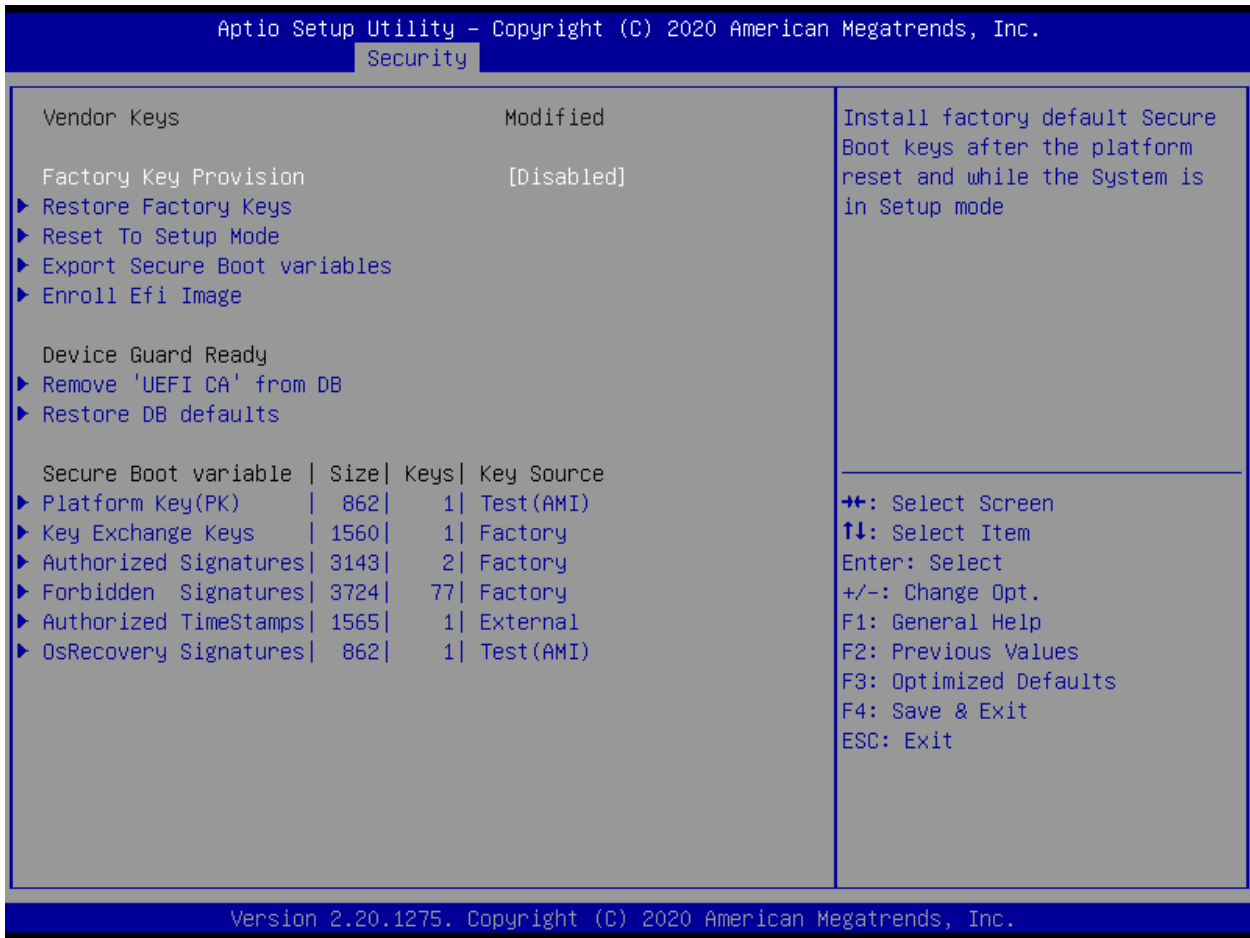

Item	Options	Description
Factory Key Provision	Disabled [Default] , Enabled	Install factory default Secure Boot keys after the platform reset and while the System is in Setup mode

Item	Description
Restore Factory Keys	Force System to User Mode. Install factory default Secure Boot key databases
Enroll Ffi Image	Allow Efi image to run in Secure Boot mode. Enroll SHA256 Hash certificate of a PE image into Authorized Signature Database (db)

4.6 Boot

This menu allows you to setup the system boot options.

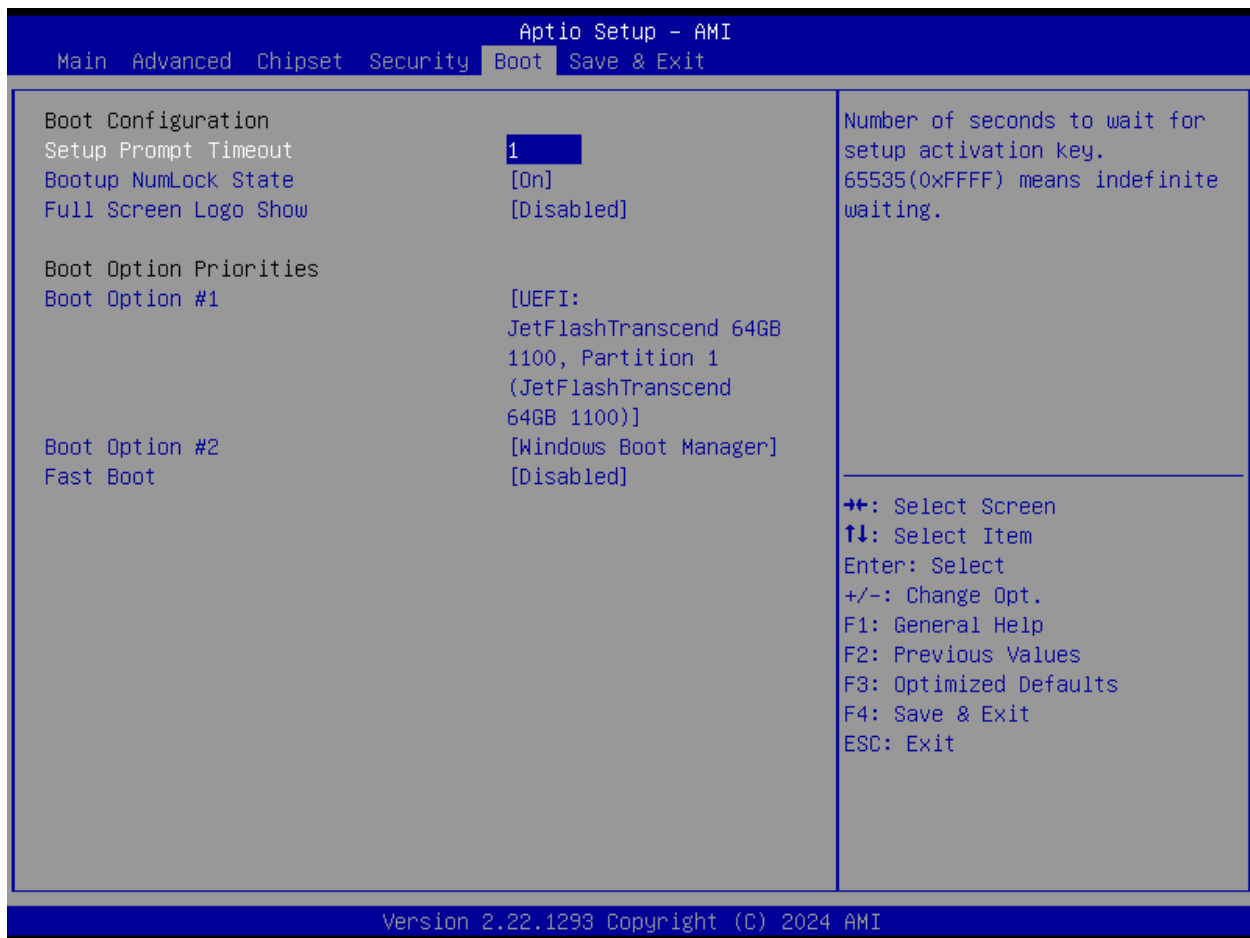

Item	Options	Description
Setup Prompt Timeout	1[Default]	Number of seconds to wait for setup activation key. 65535(0xFFFF) means indefinite waiting.
Bootup NumLock State	On[Default], Off	Select the Keyboard NumLock state.
Full Screen Logo Show	Disabled[Default], Enabled	Enables or disables Full Screen Logo Show option.
Fast Boot	Disabled[Default], Enabled	Enables or disables boot with initialization of a minimal set of devices required to launch active boot option. Has no effect for BBS boot options.
Boot Option #1		Set the system boot order.

4.7 Save & Exit

This setting allows users to configure the boot settings.

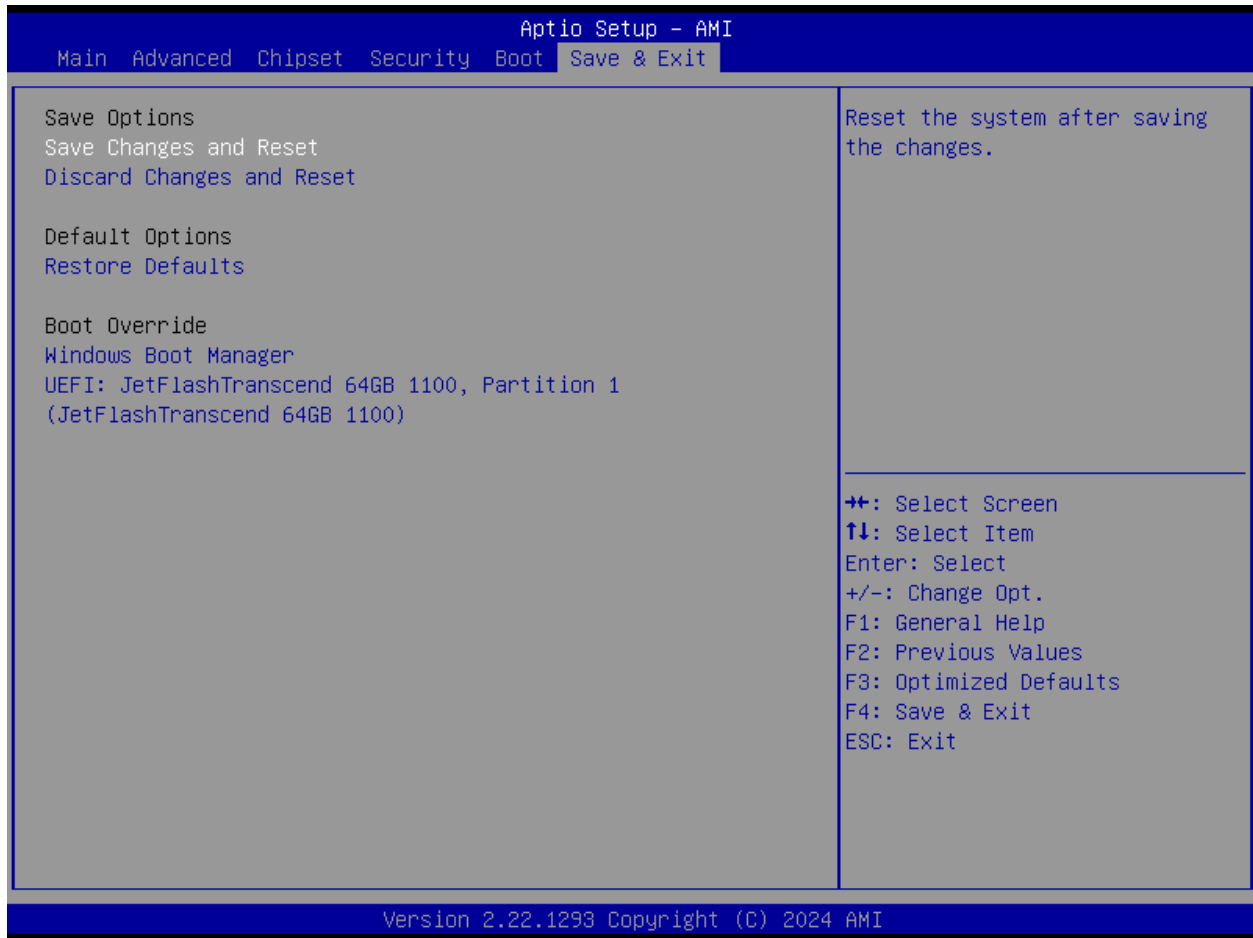

■ Save Changes and Reset

This item allows user to reset the system after saving the changes. This item allows user to reset the system after saving the changes.

■ Discard Changes and Reset

This item allows user to reset the system without saving any changes.

■ Restore Defaults

Use this item to restore /load default values for all the setup options.

Appendix

WDT & GPIO

This appendix provides the sample codes of WDT (Watch Dog Timer) and GPIO (General Purpose Input/ Output).

WDT Sample Code

WDT Setting

Psuedo Code

// IO Address 0xA16 is time value(second)

// IO Address 0xA15 is WDT enable and configuration

Example, Set 0xA16=0x02, 0xA15=0x31, it will reset after 2 seconds

```
#define TimePort      0xA16
```

```
#define TimeEnablePort 0xA15
```

//Set WDT Time Unit

```
buf1 = ReadByte(TimeEnablePort) & 0xf7; //Clear WDT mode.
```

```
// buf1 |= 0x08; //Bit3 :(1:Minute Mode/0:Second Mode)
```

```
WriteByte(TimeEnablePort, buf1);
```

//Set WDT Time Value

```
WriteByte (TimePort , 0x02); // Set 2 seconds
```

//Enable WDT

```
buf1 = ReadByte(TimeEnablePort);
```

```
buf1 |= 0x31;
```

```
    //Bit5 :WD_EN,If this bit is set to 1, the counting of watchdog time is enabled.
```

```
    //Bit4 :WD_PULSE ,Select output mode (0: level, 1: pulse) of WDTRST# by setting this bit.
```

```
    //Bit1~0: Select output pulse width of WDTRST#. 0: 1 ms, 1: 25 ms, 2: 125 ms, 3: 5 sec.
```

```
WriteByte(TimeEnablePort, buf1);
```

// Disable WDT

```
buf1 = ReadByte(TimeEnablePort); // Read current WDT setting
```

```
buf1 = buf1 & 0xDF; // Disable WDT by set WD_EN (bit 5) to 0.
```

```
WriteByte(TimeEnablePort, buf1); // Write back WDT setting.
```

GPIO Sample Code

GPIO Setting

IO_DO4	I/O 0xA02h Bit3
IO_DO3	I/O 0xA02h Bit2
IO_DO2	I/O 0xA02h Bit1
IO_DO1	I/O 0xA02h Bit0
IO_DI4	I/O 0xA03h Bit3
IO_DI3	I/O 0xA03h Bit2
IO_DI2	I/O 0xA03h Bit1
IO_DI1	I/O 0xA03h Bit0

The GPIO function is provided by SIO, and it can be accessed through its GPIO port. To access the GPIO register, write value to data port. The configuration on the RCO-1000-ASL is described as below.

Pseudo Code

```
#define GPI_ADDR 0xA03h
```

```
#define GPO_ADDR 0xA02h
```

```
// 0xA03h is Pin Status(default 0x5F )(at IO_DI1(Bit0) ~ IO_DI4(Bit3))
```

```
ByteData = ReadByte (GPI_ADDR) //Read current Pin Status
```

```
//Offset 0xA02h default setting is 0x5F (output pin set to output high) (at IO_DO1(Bit0) ~ IO_DO4(Bit3))
```

```
ByteData = 0x0F //set IO_DO1~ IO_DO4 to high
```

```
WriteByte (GPO_ADDR, ByteData)
```

